

HUNTER DOUGLAS
FALL 2007

















FRONT

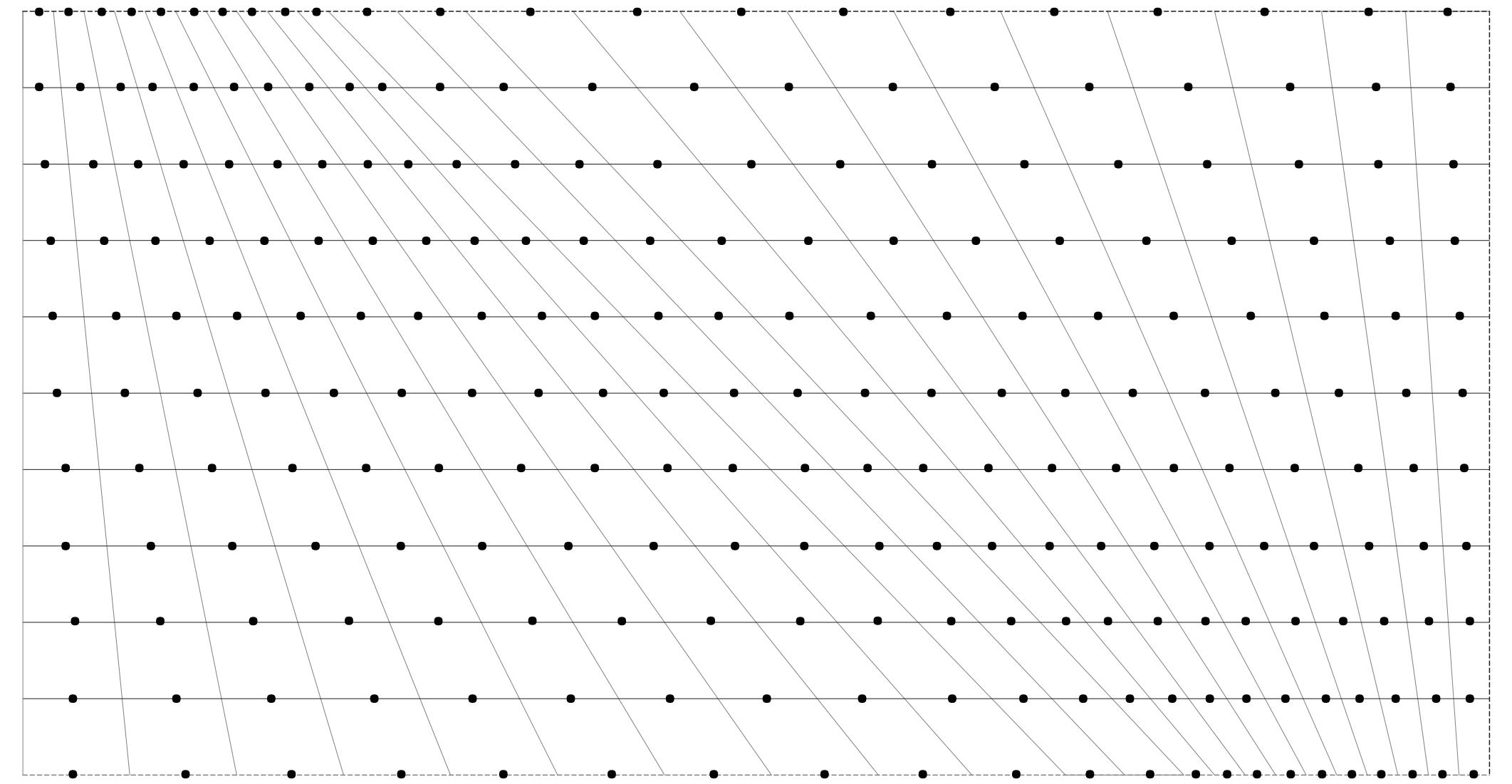
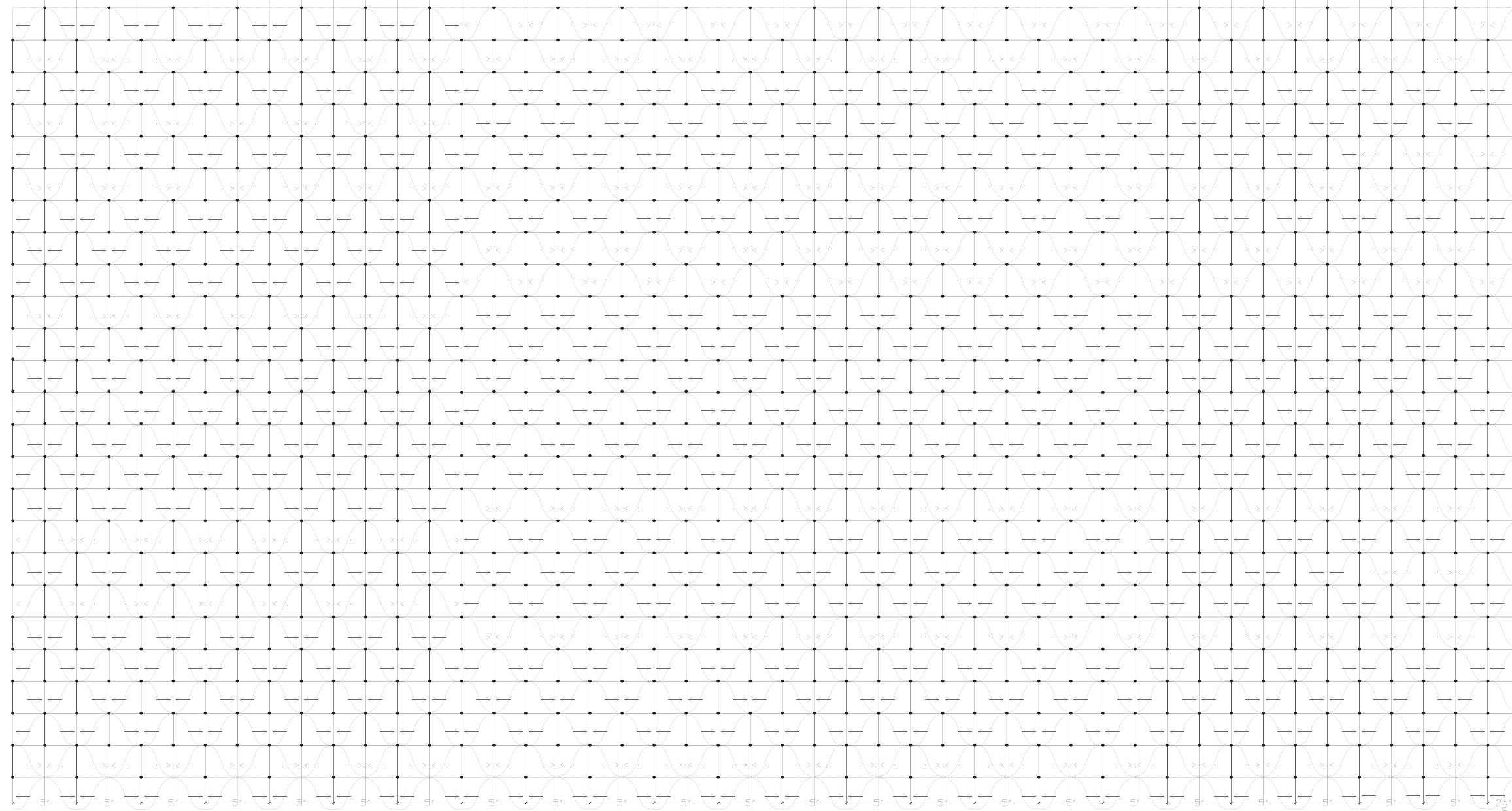

BACK

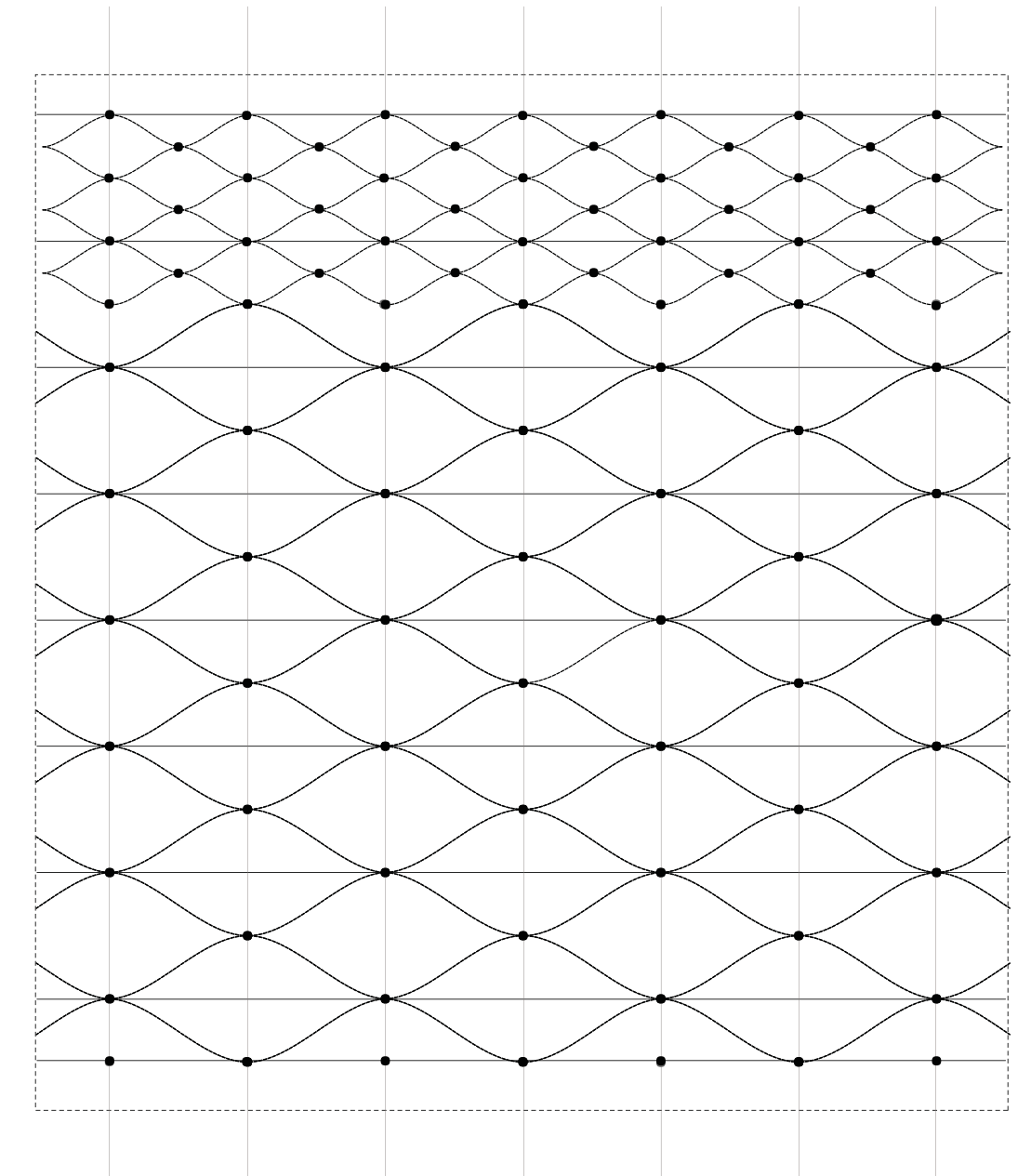
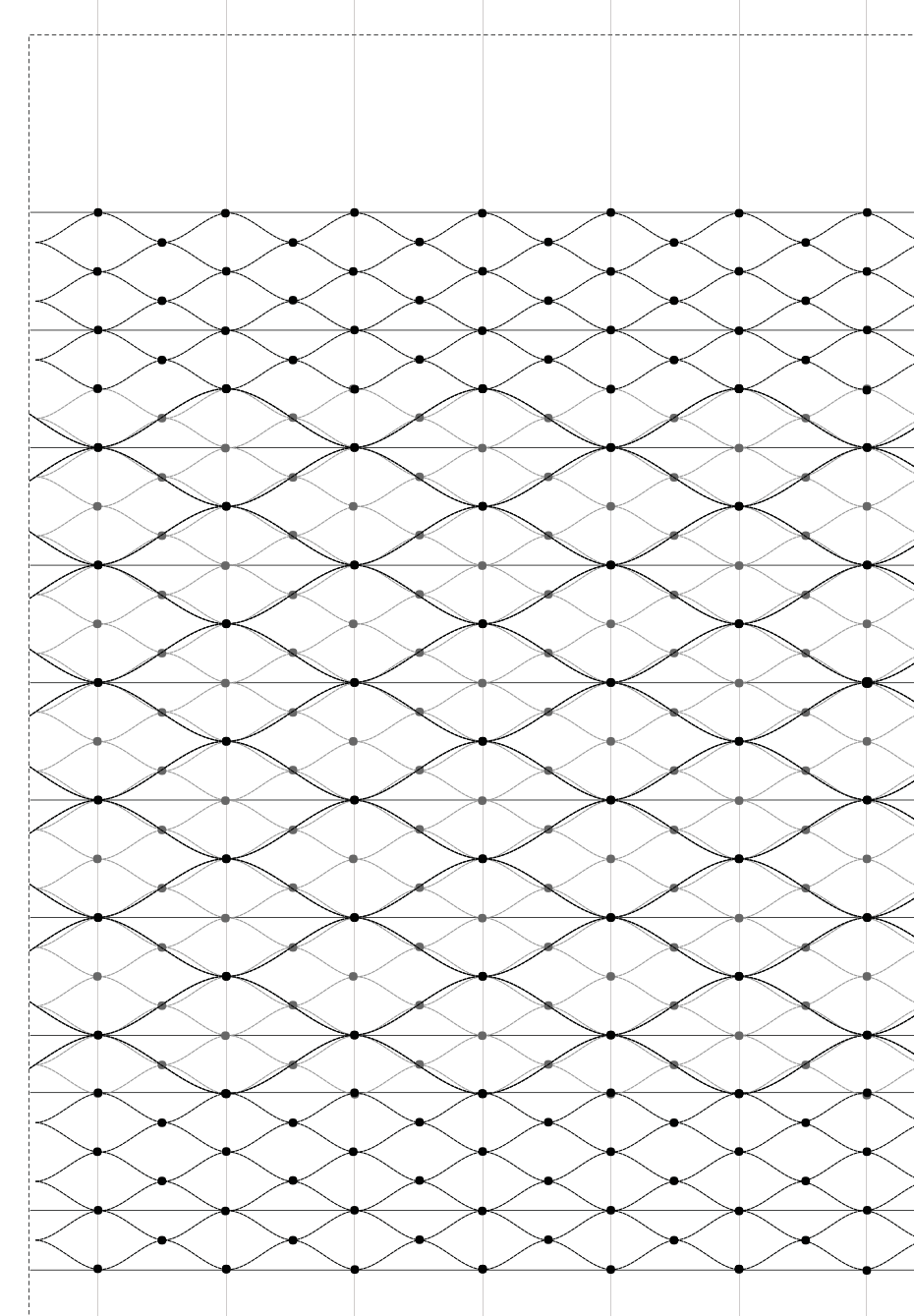
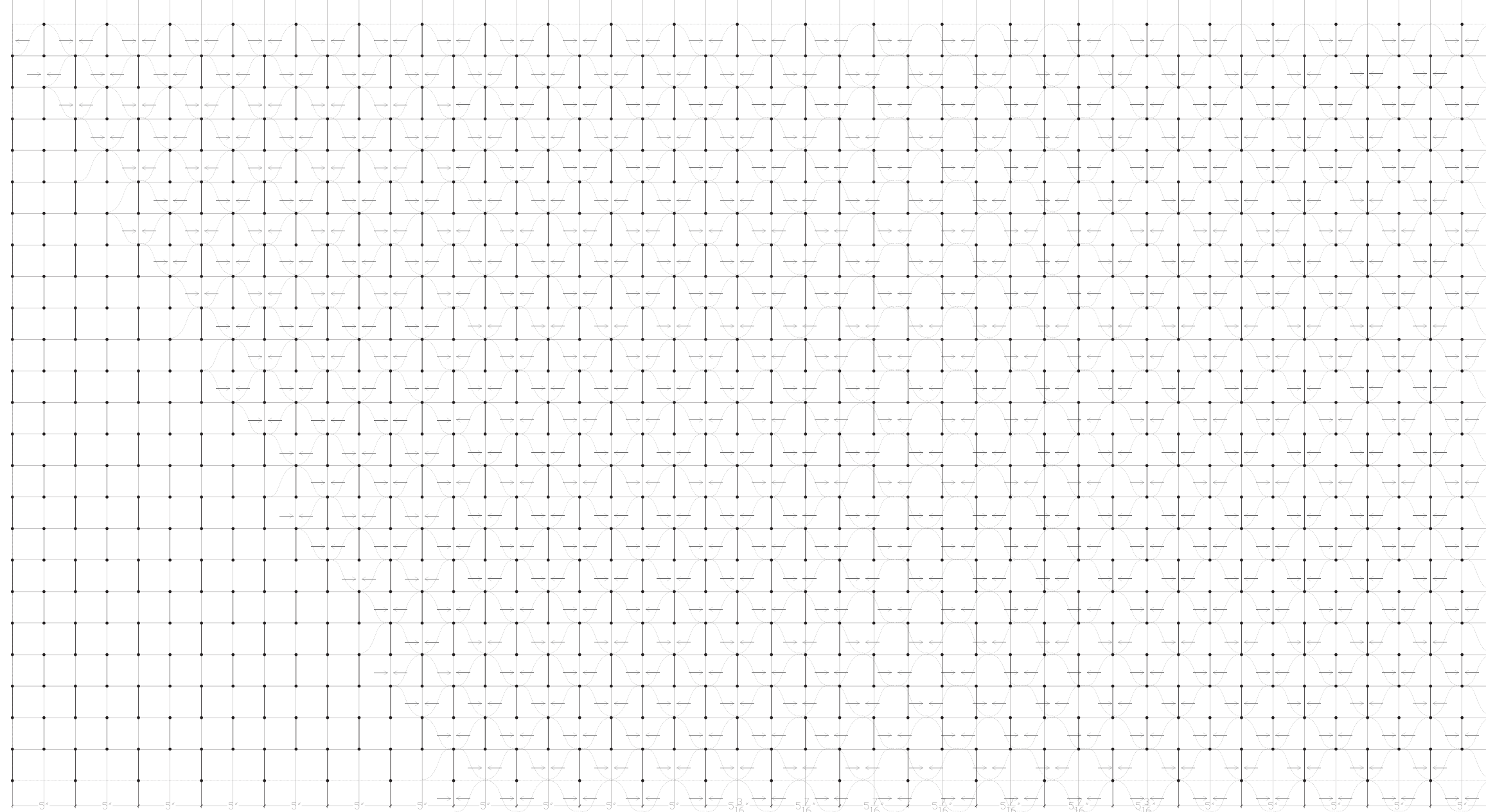

CUBEOCTOHEDRON ARCH
SUMMER/FALL 2008

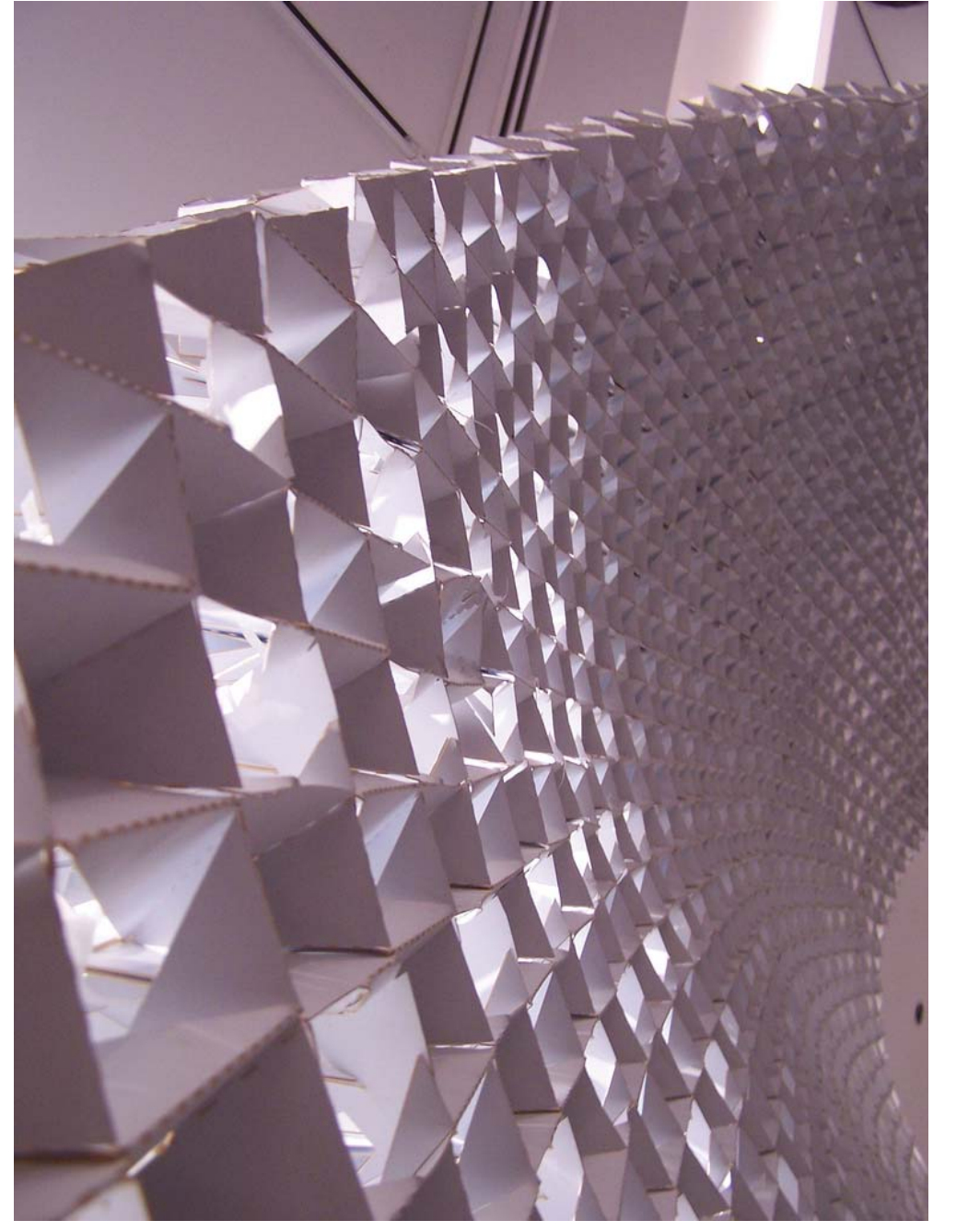



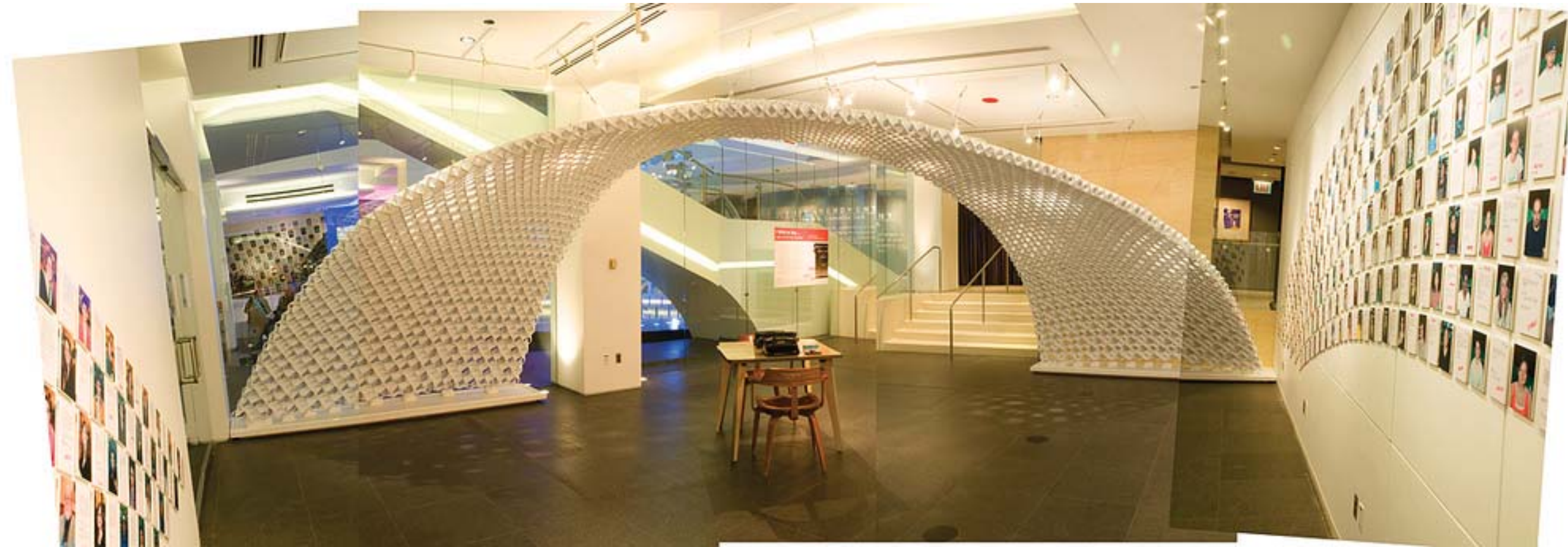
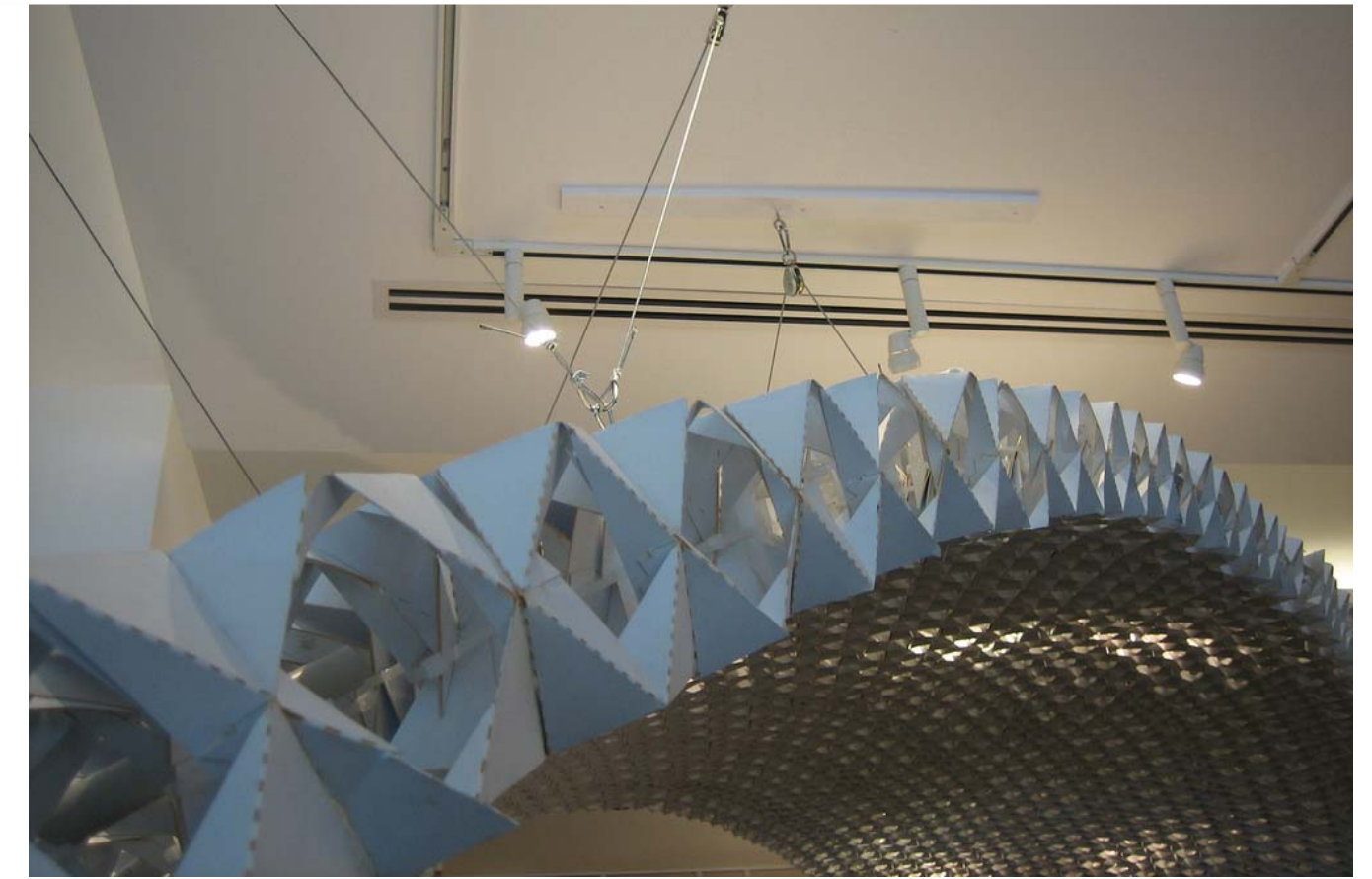
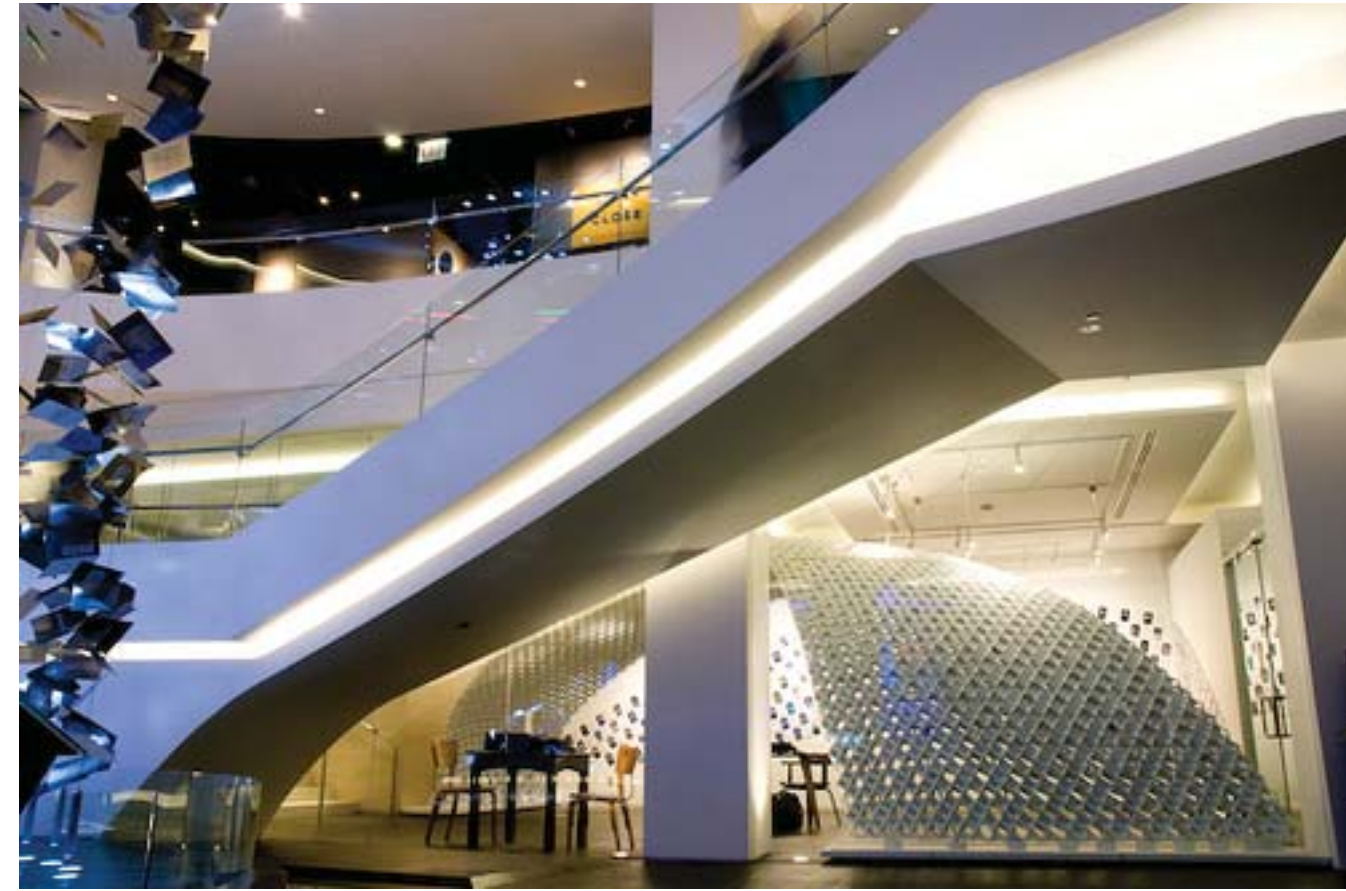

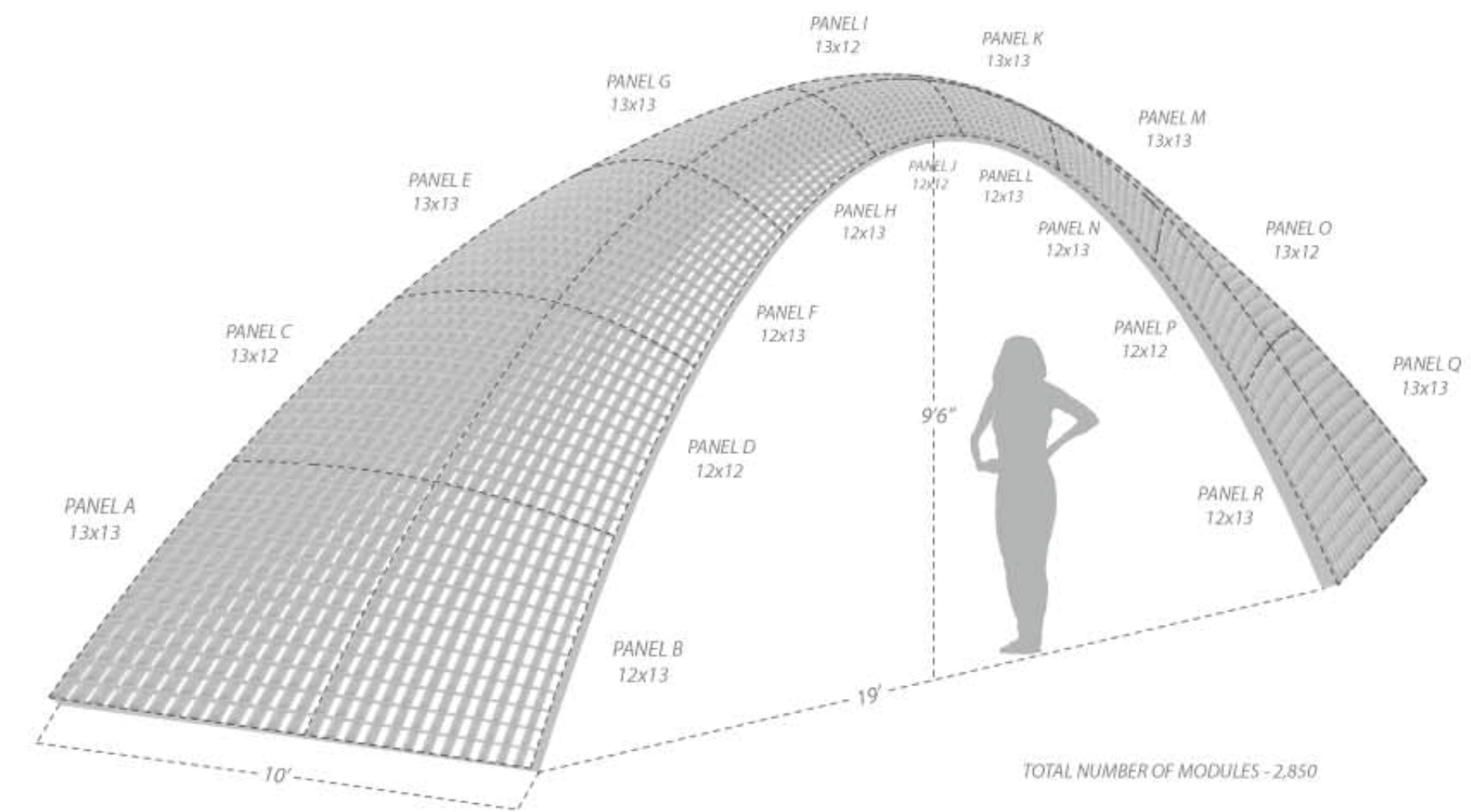
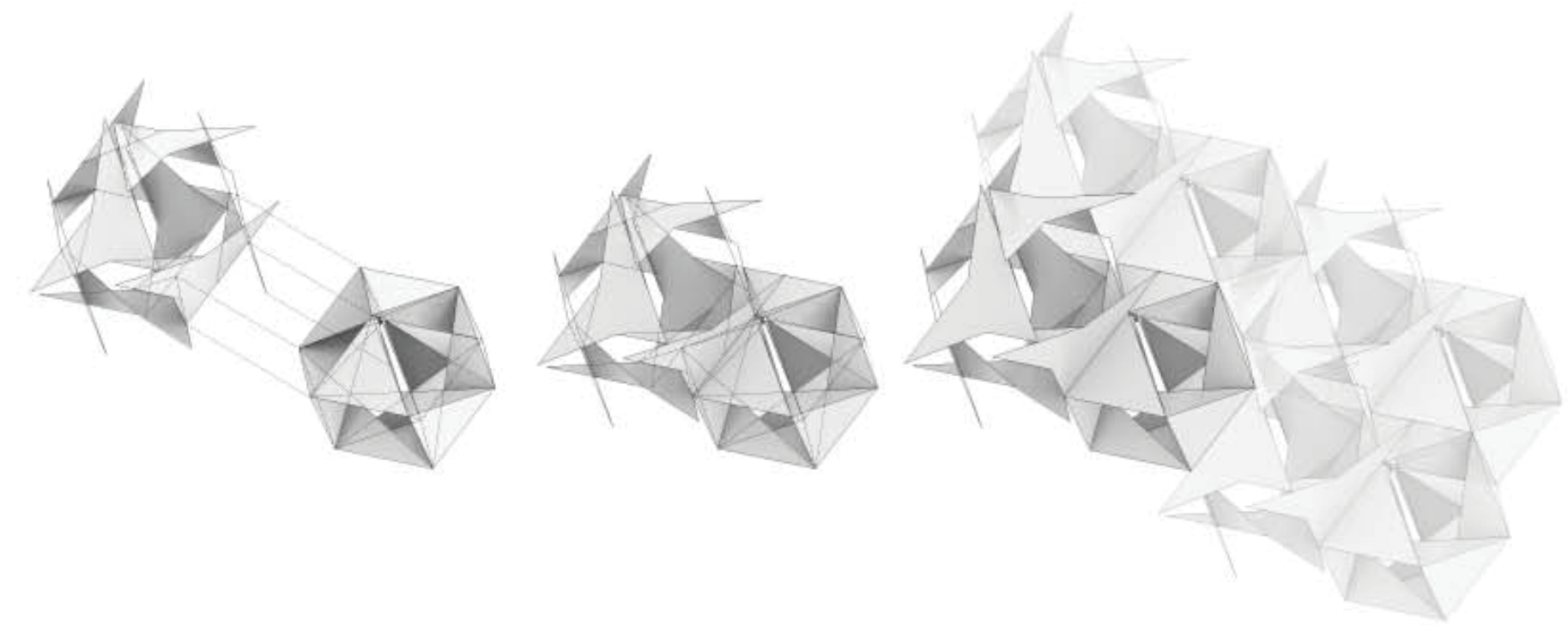
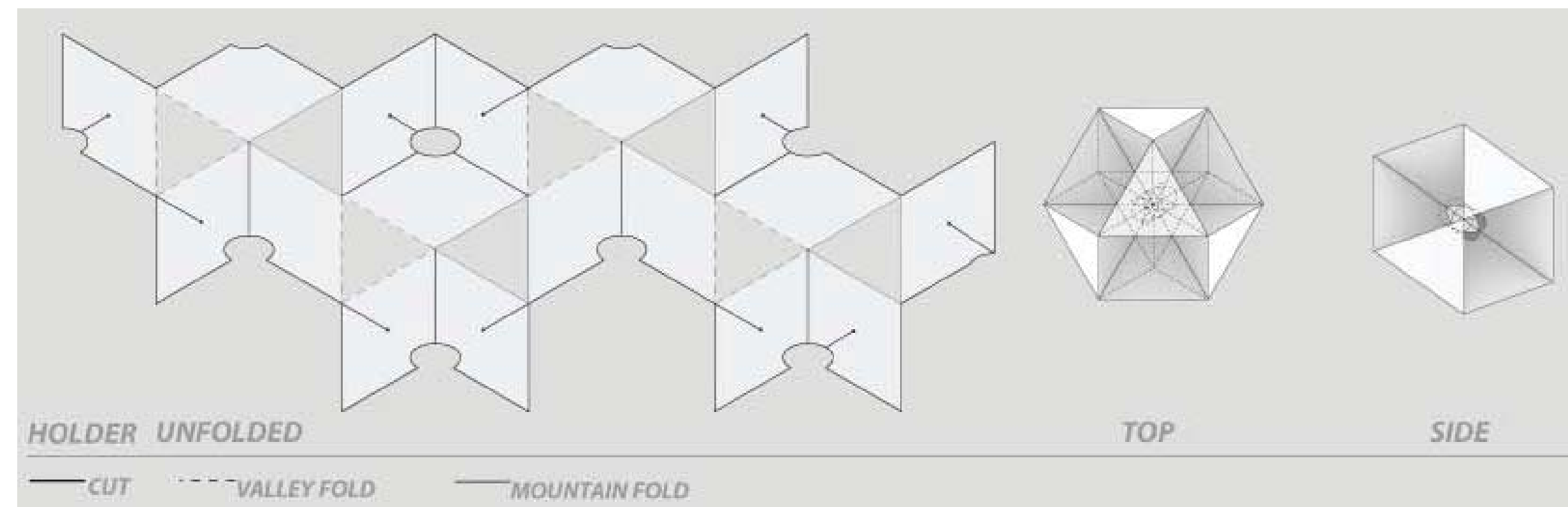
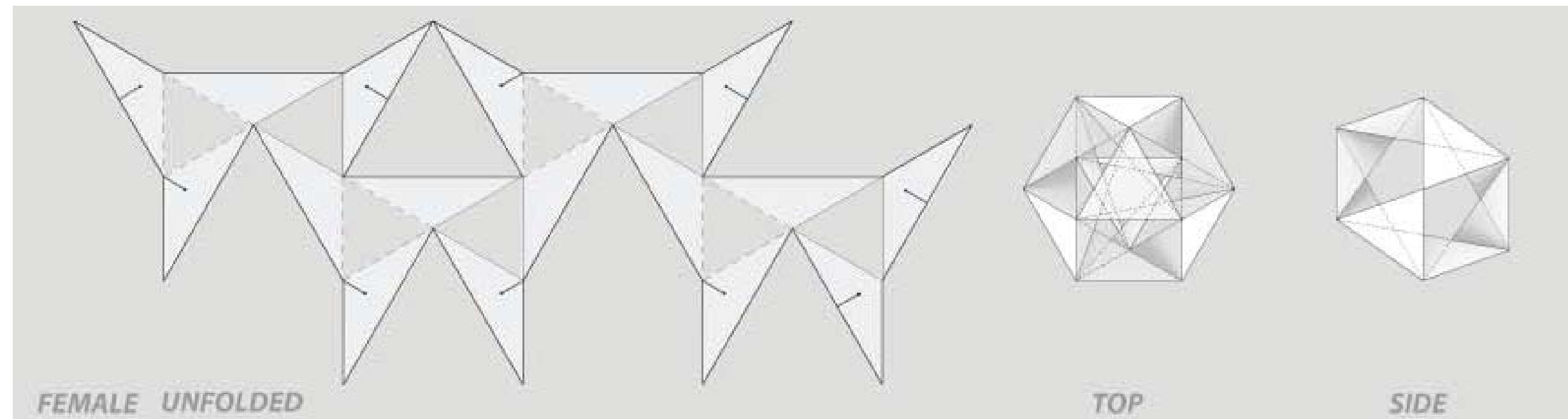
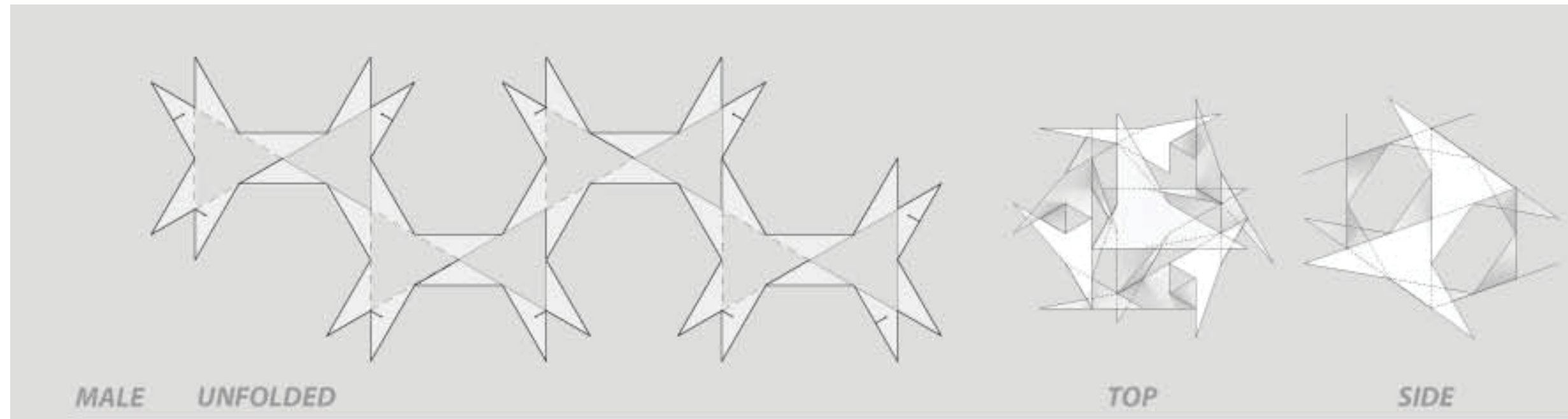

DISHWARE
FALL 2008

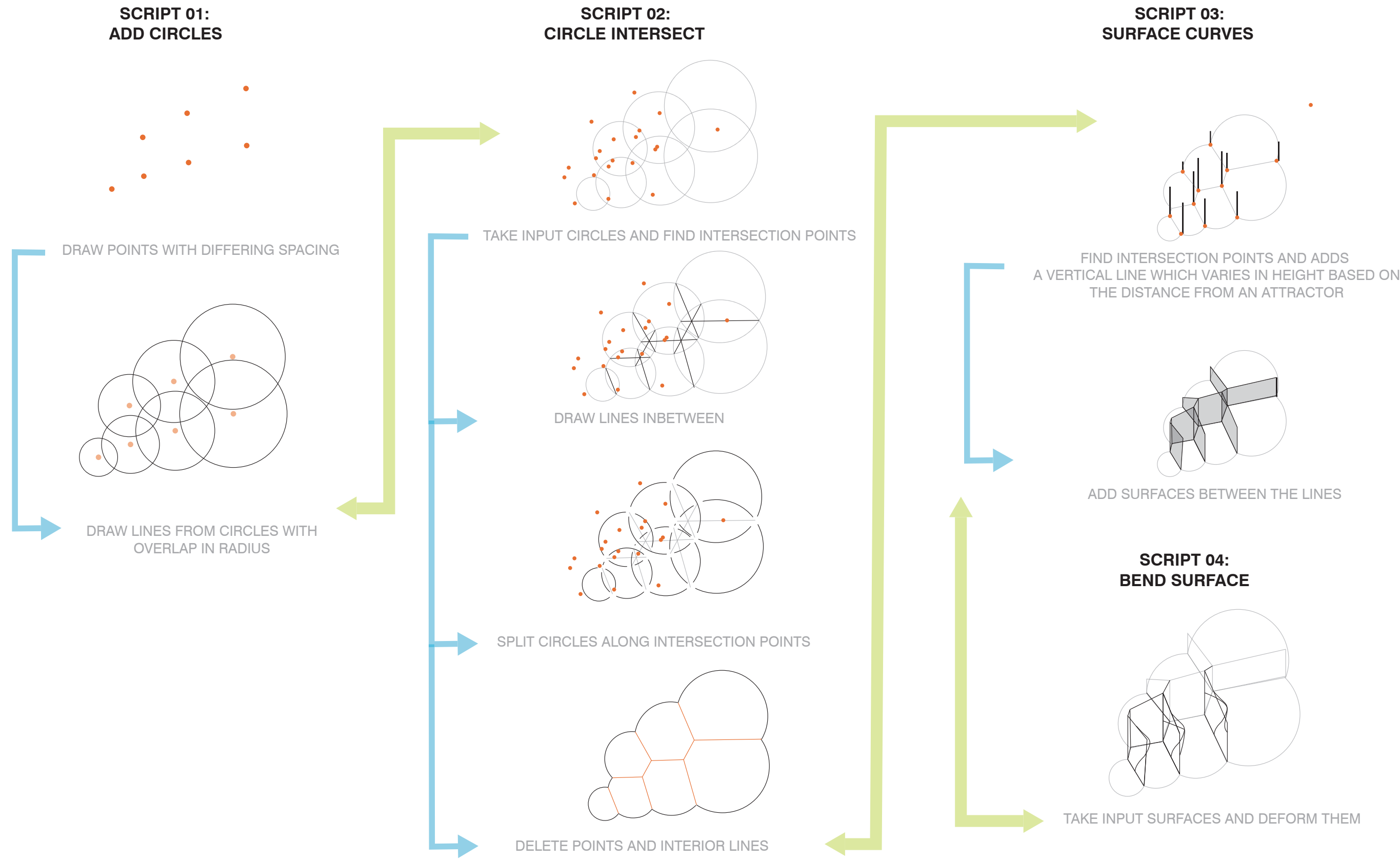
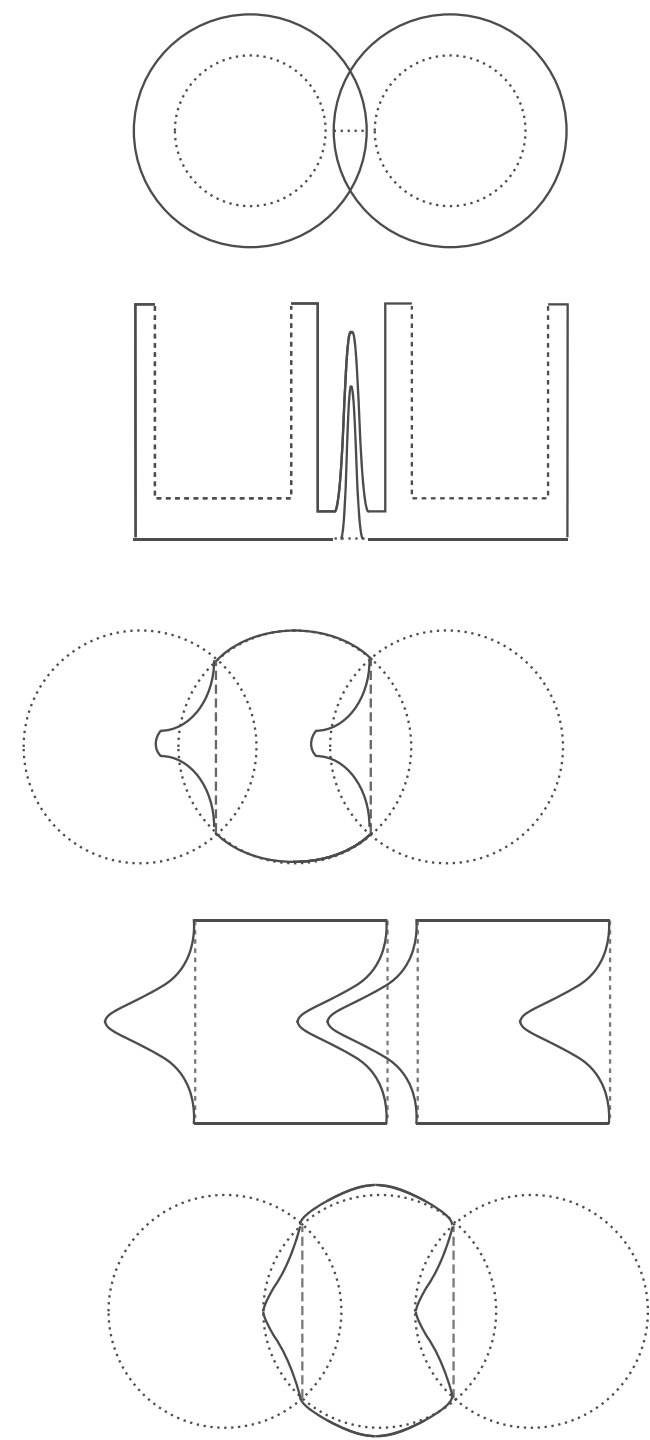
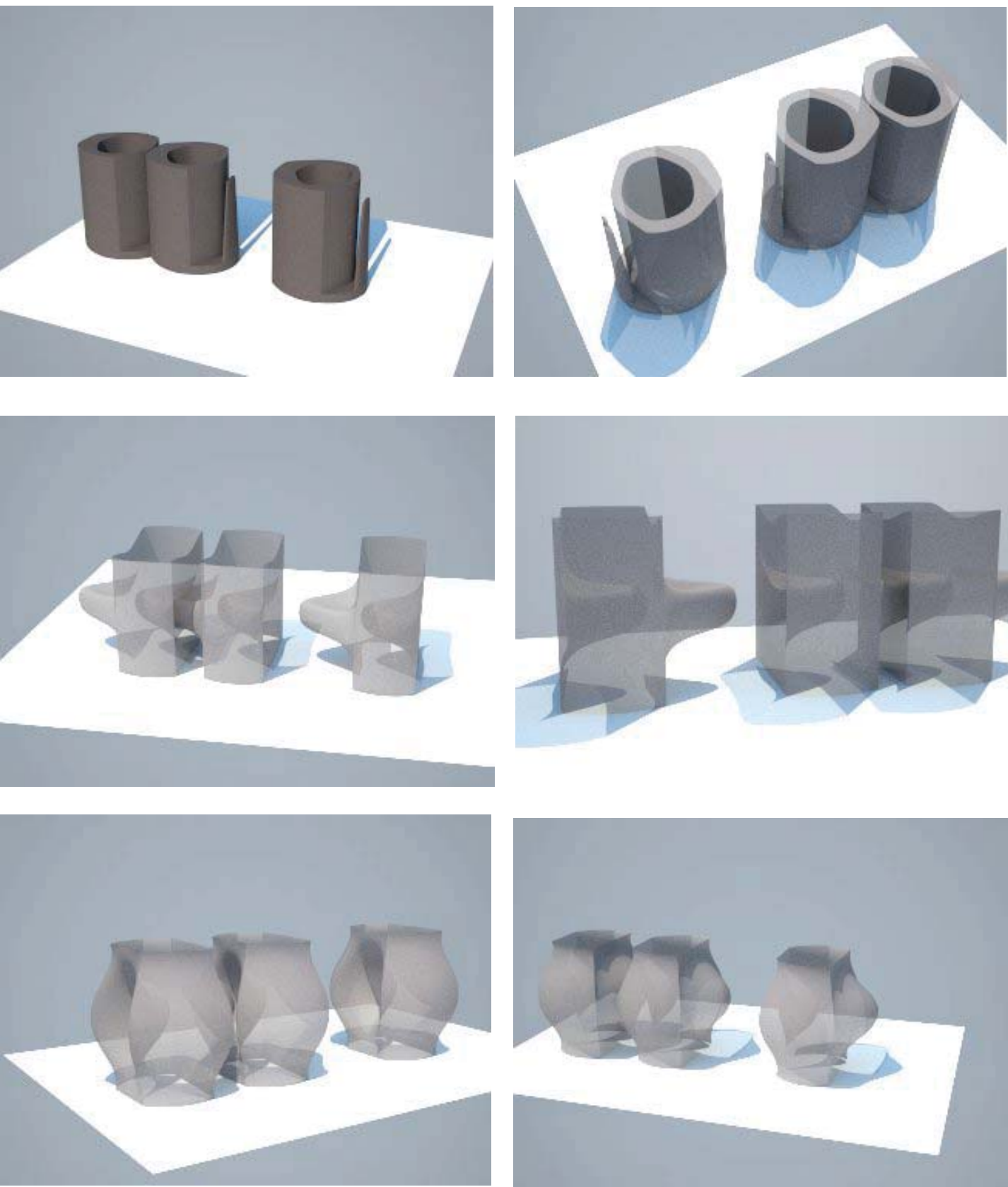



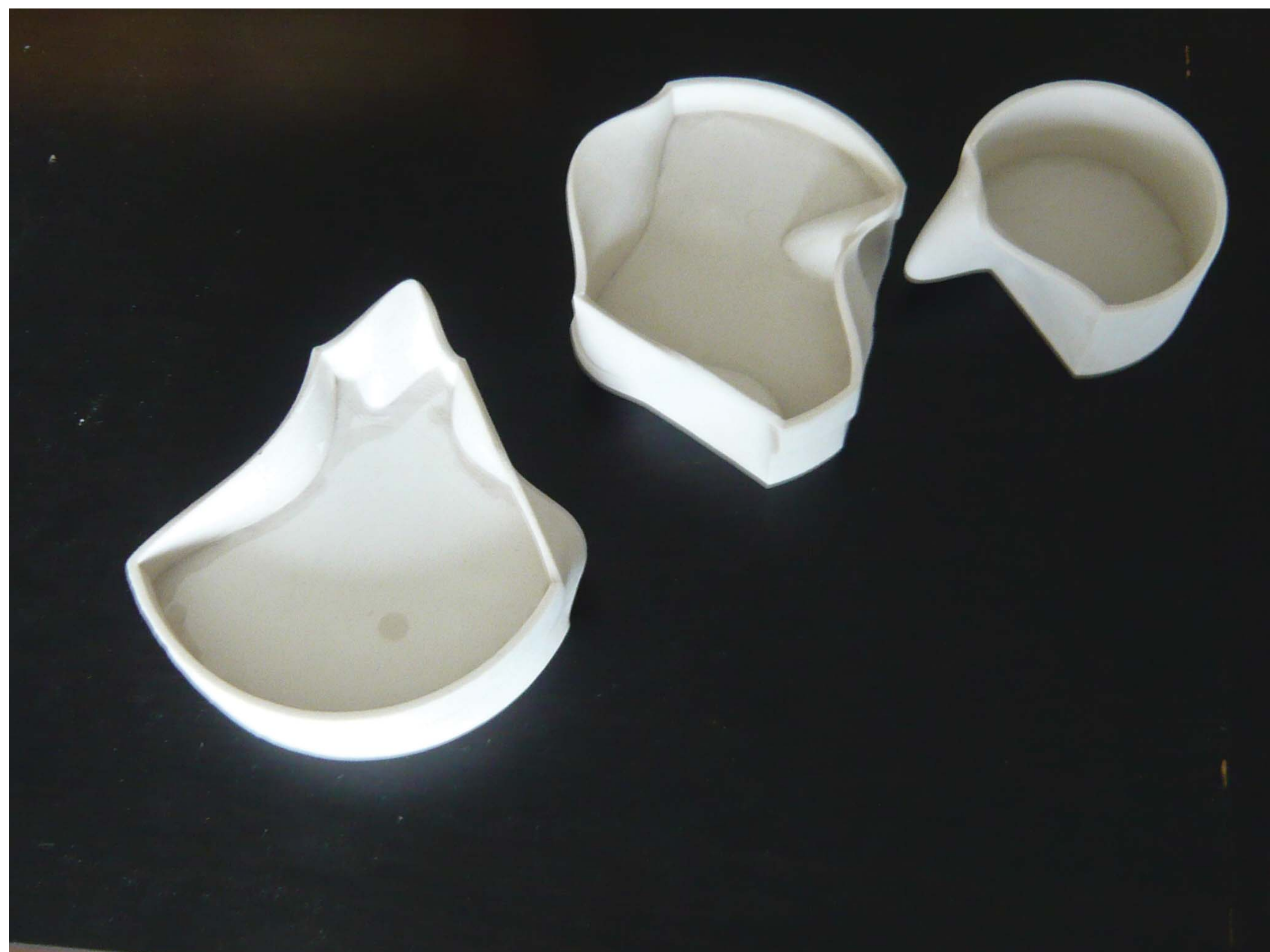

OCTOLIER
SPRING 2009

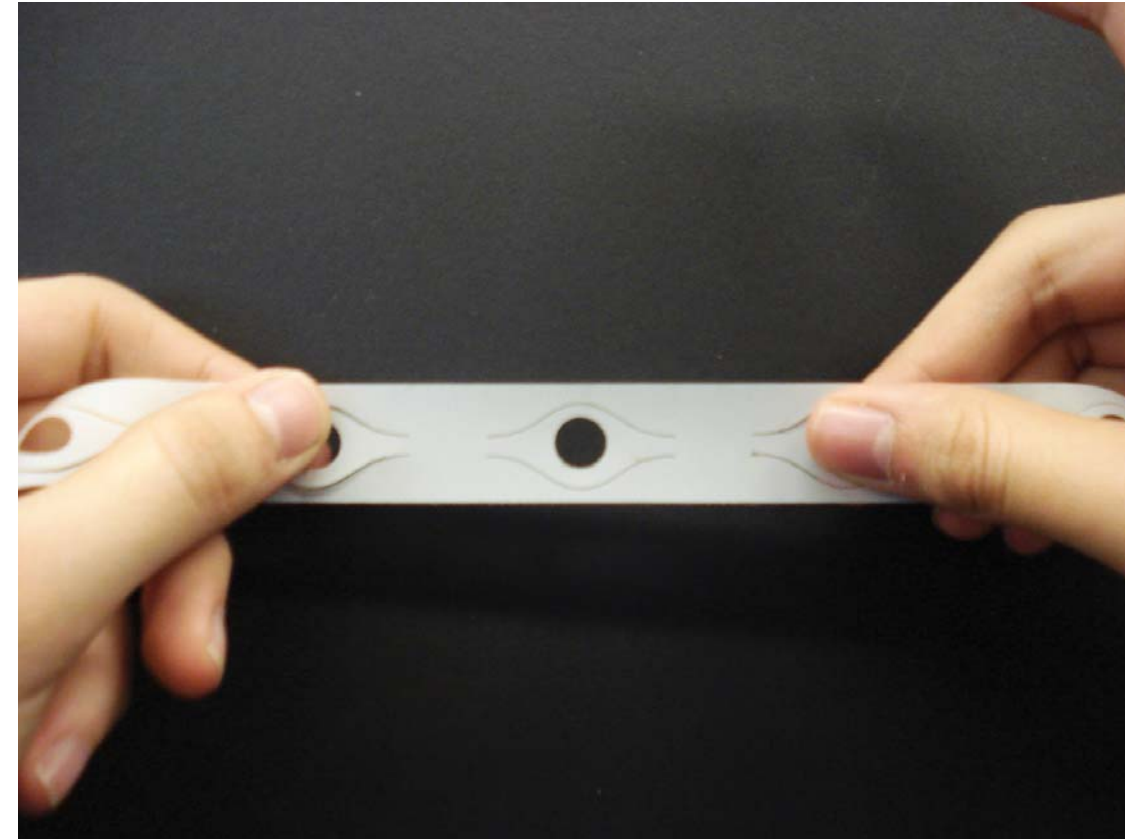

LASER CUT LIGHT STRIP

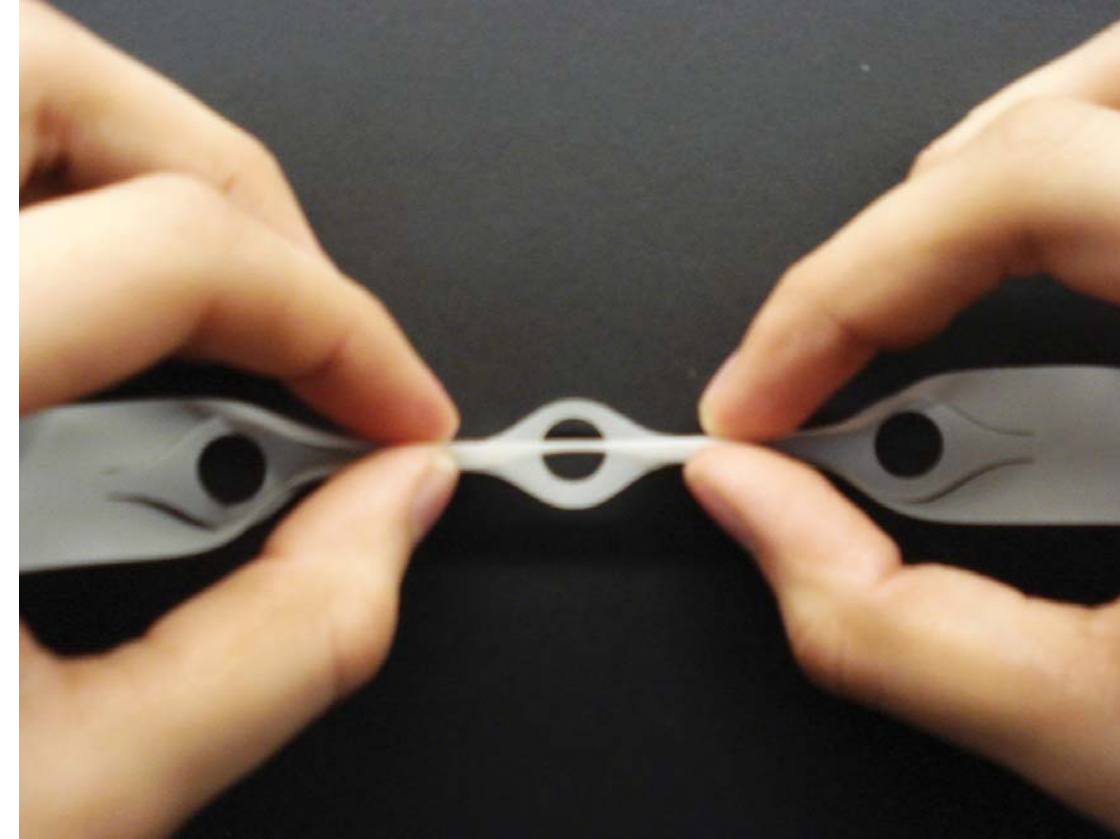

PINCH SIDES TOGETHER



APPLY ADHESIVE STRIP AROUND SIDES

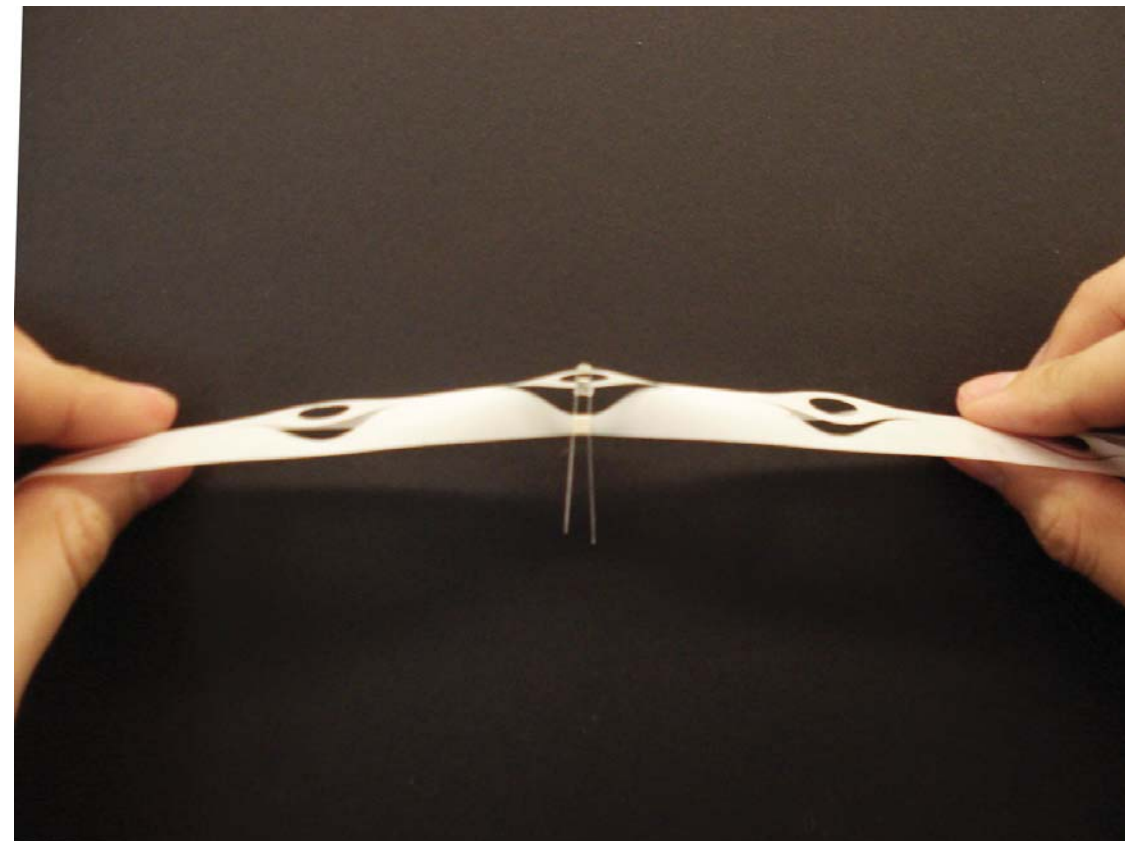
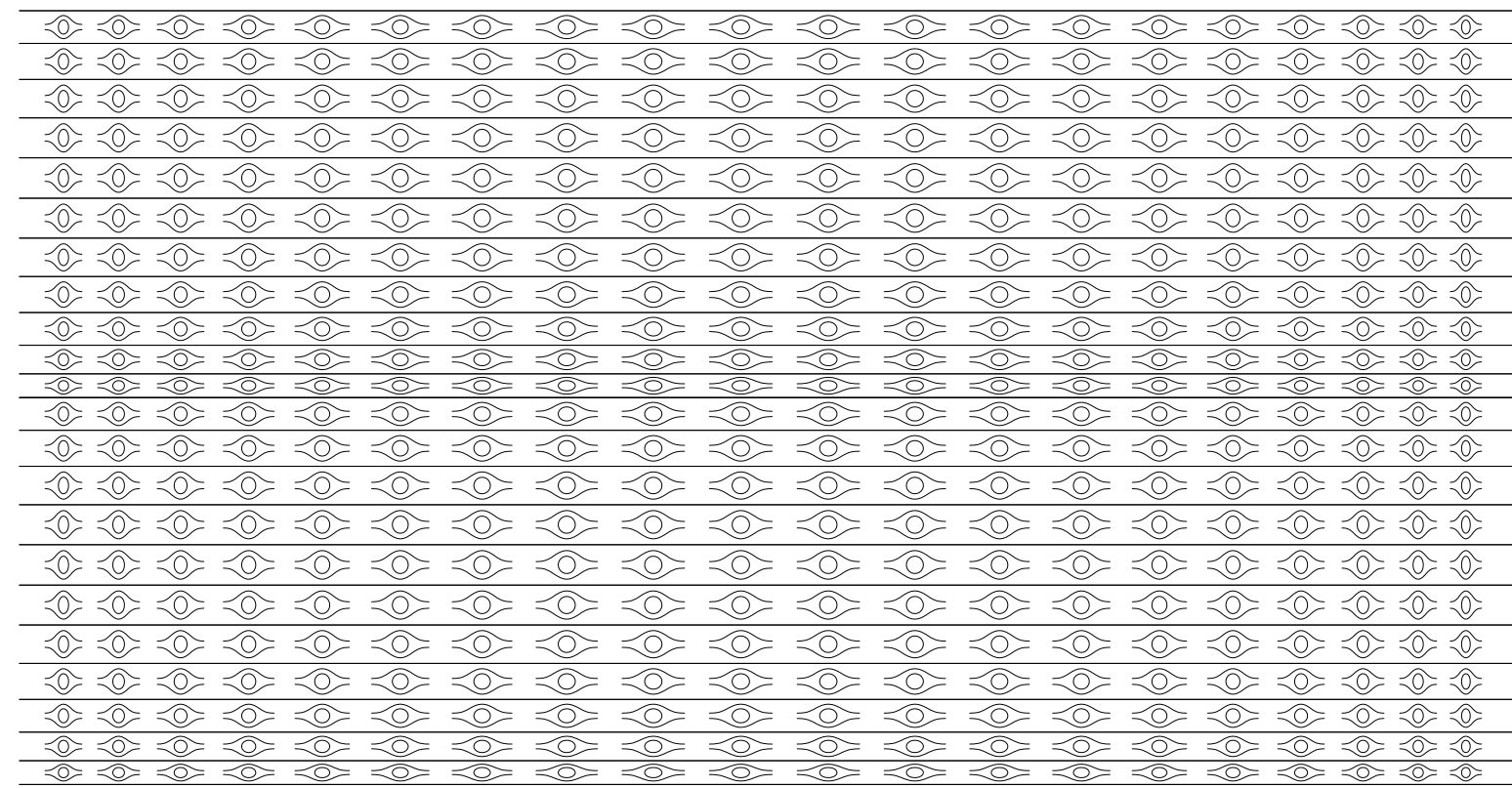

INSERT LED AROUND PINCHED SIDES



LED IN PLACE

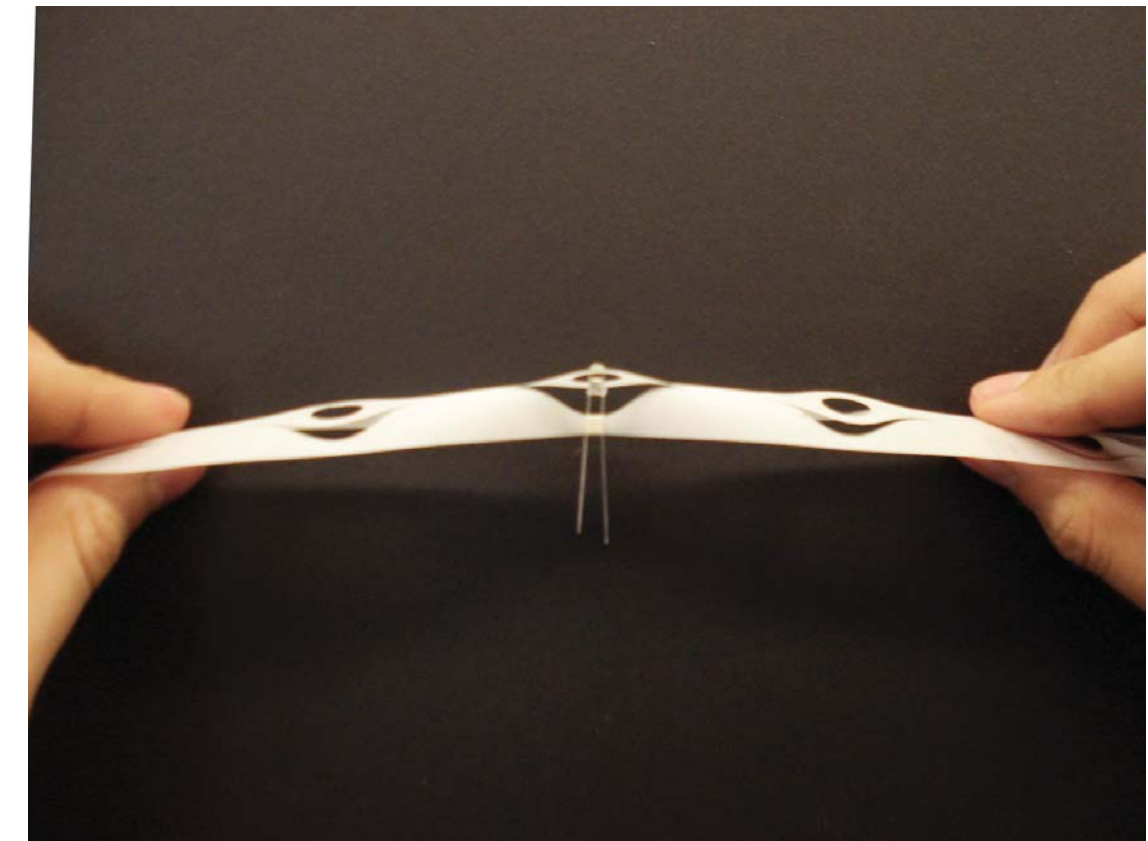

WIRE LED BACK TO ARDUINO

EPITHELIUM
FALL 2008





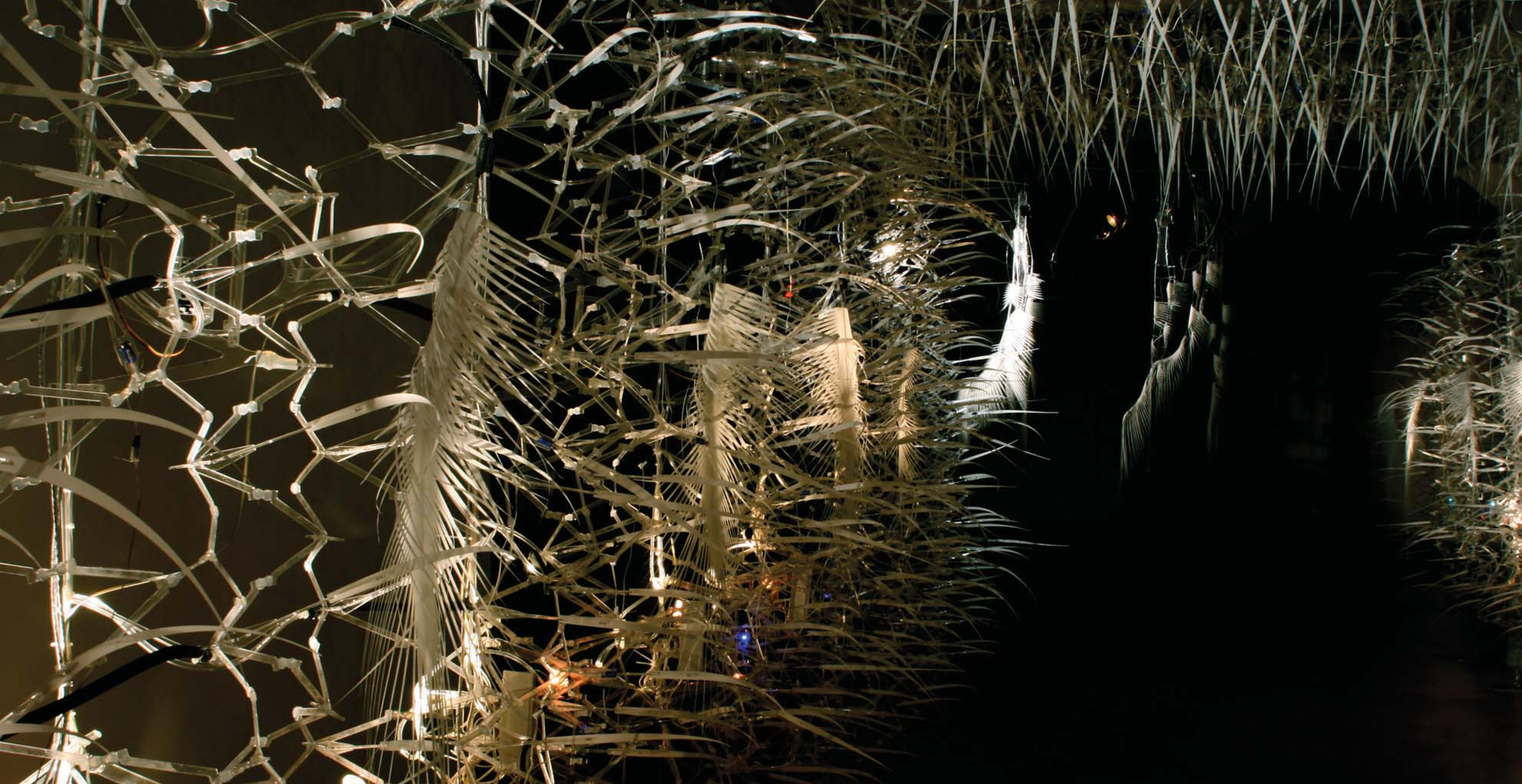





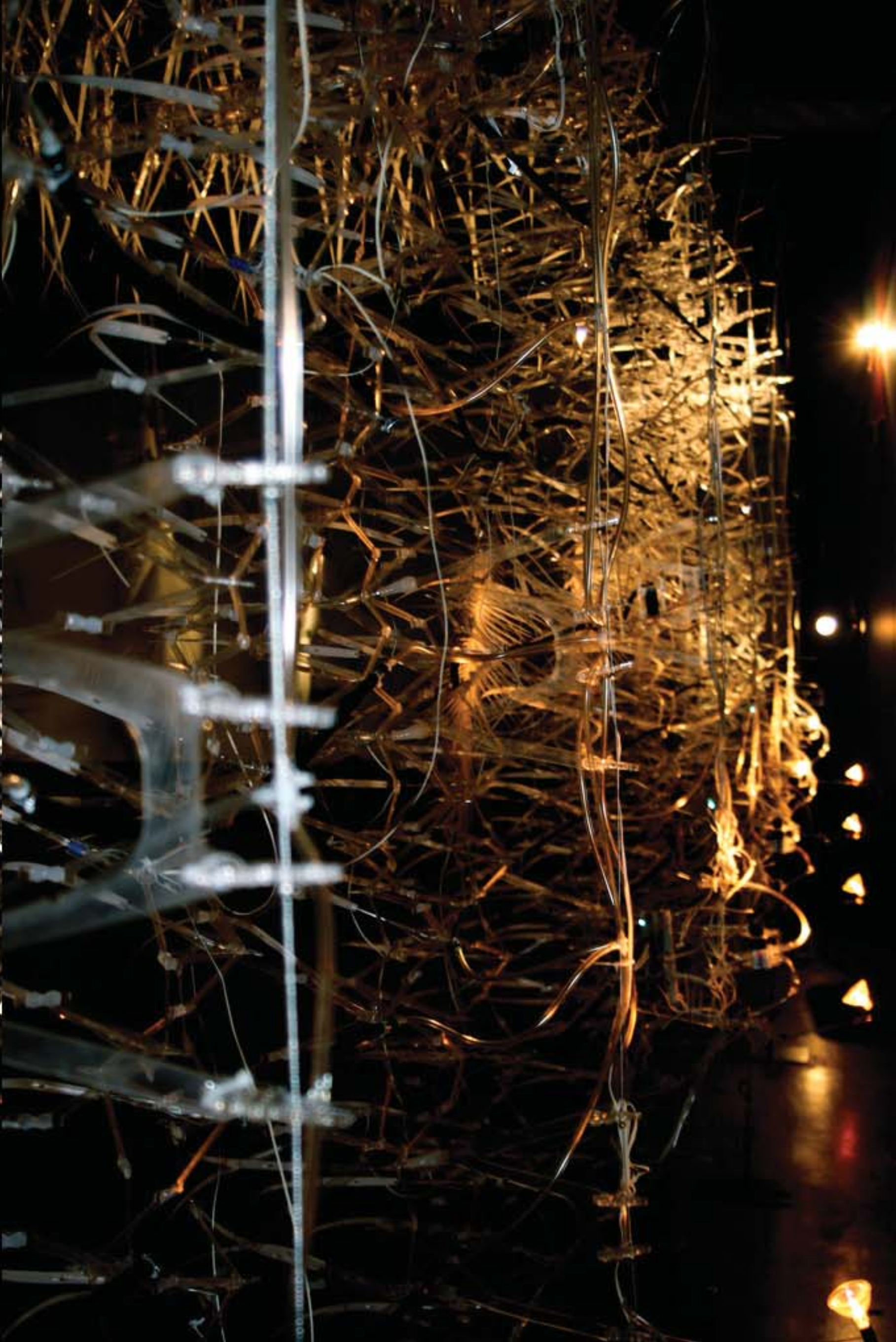

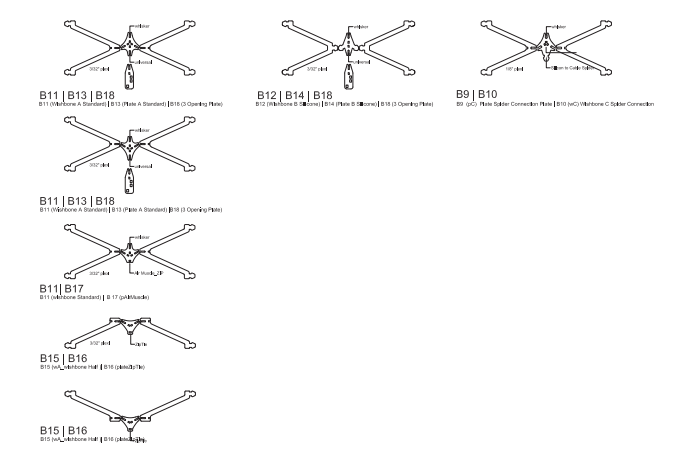

wa_3/32" snap-fit Assembly
Wishbones | Plates

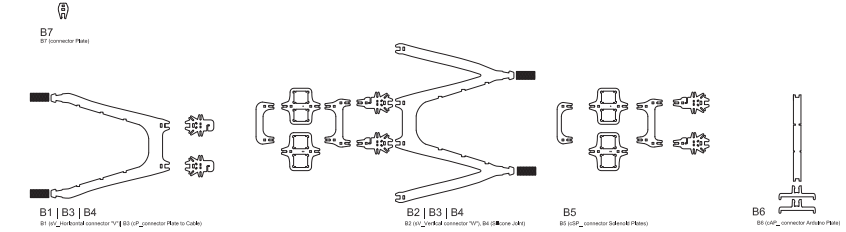

Cable Connection

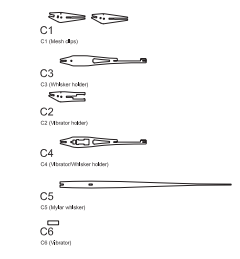

Whisker

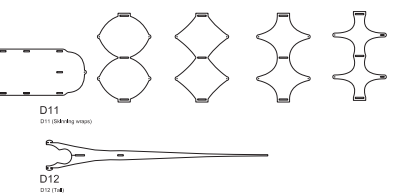
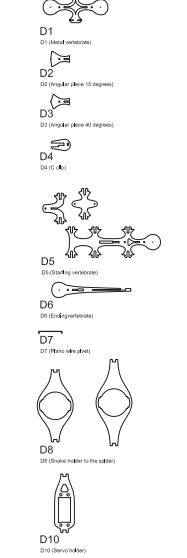

Snake

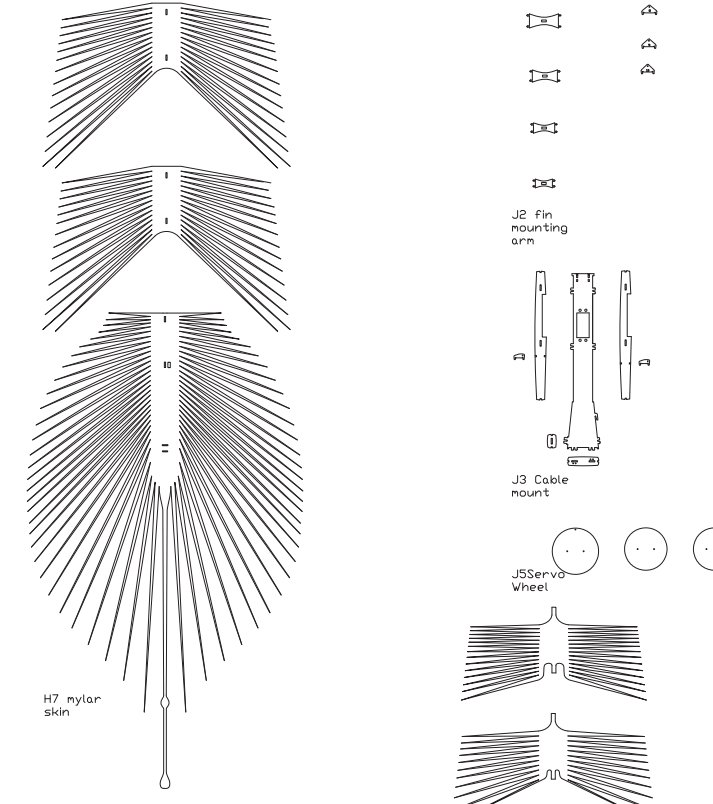
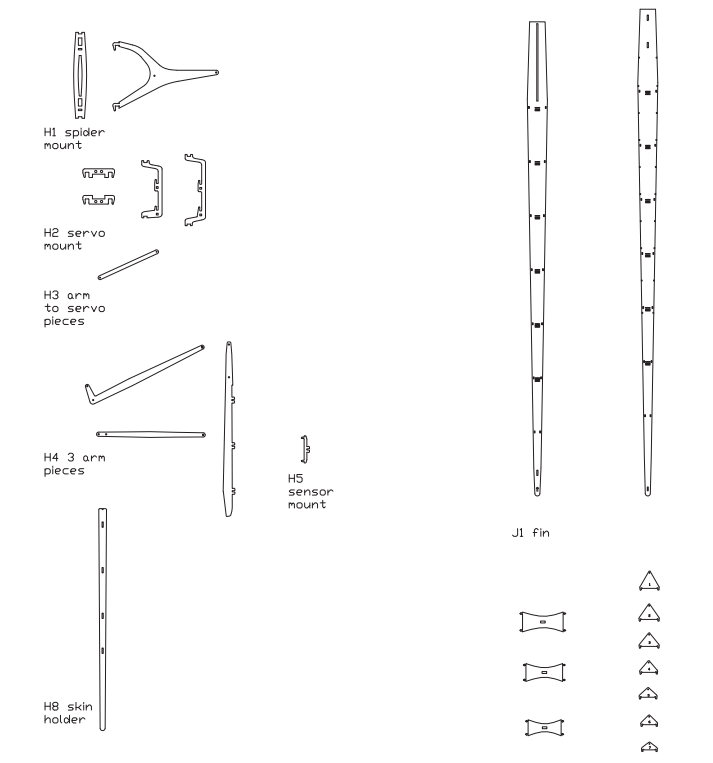

Whipping device

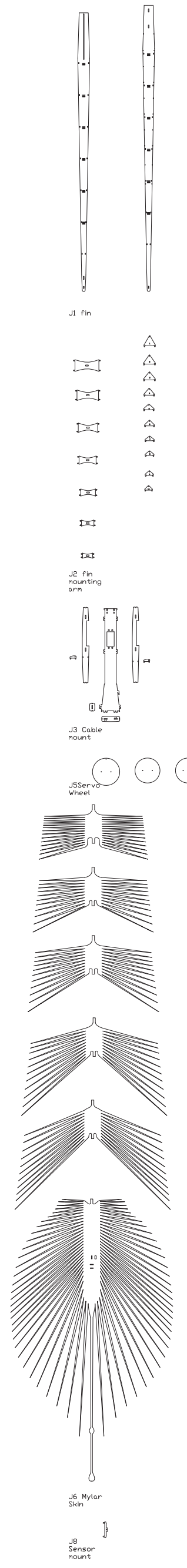

B

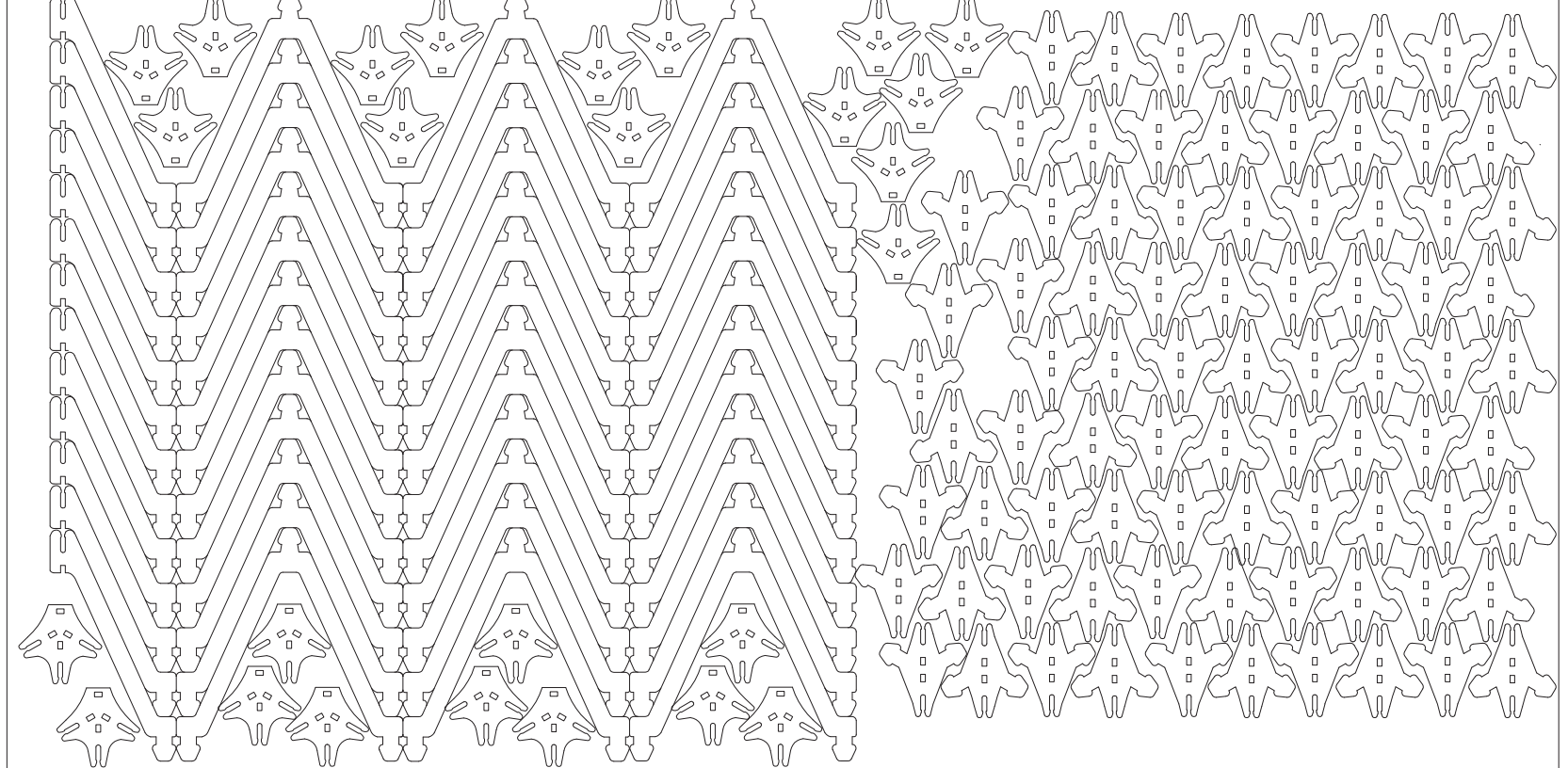
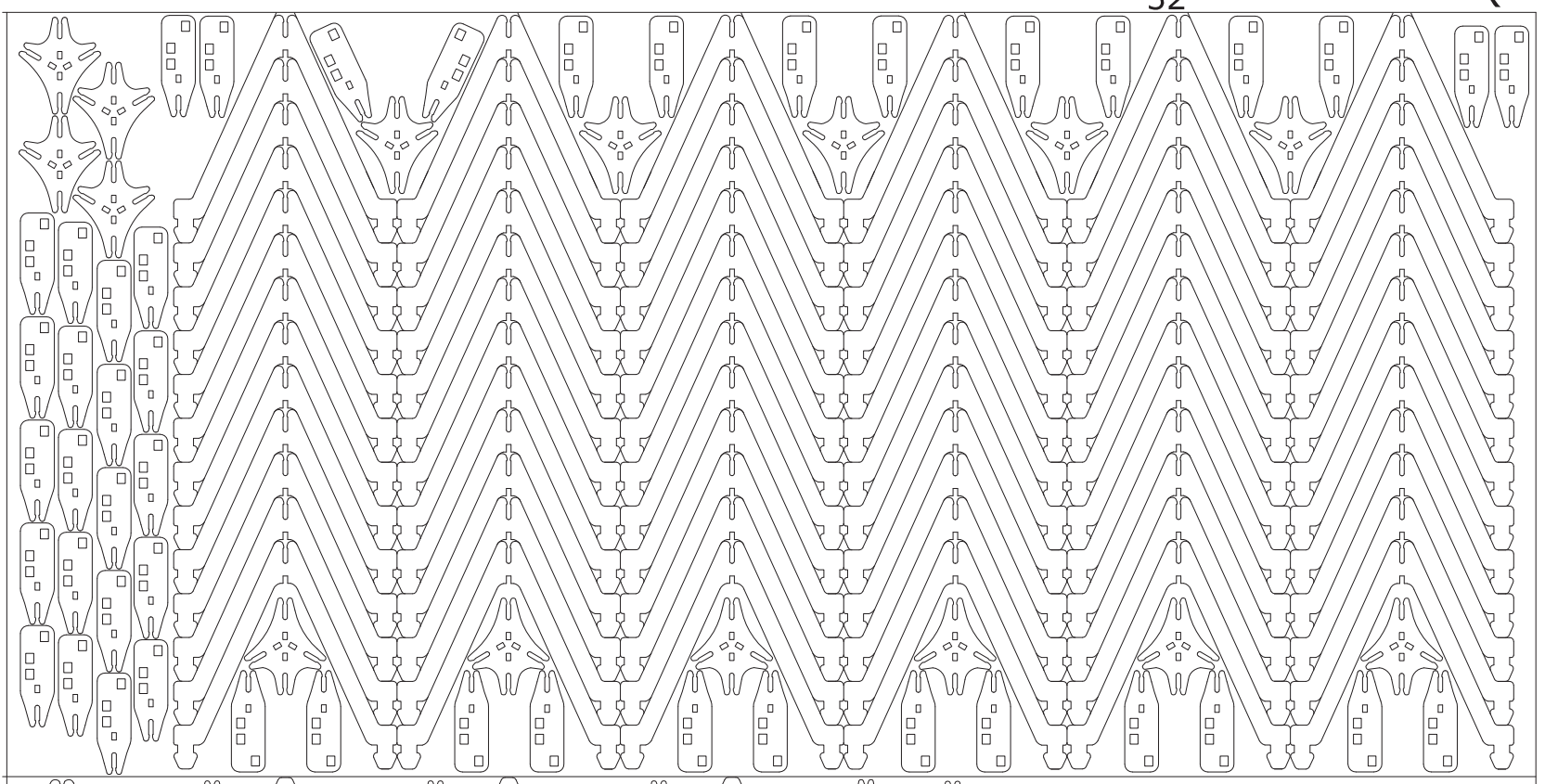

$\frac{3}{32}$ " 0.08" Plexi (x5 for 11-spiders panel)

D

AMPLE T SHEE
ME H TAX N M

$\frac{3}{32}$ " 0.08" Plexi (x1 for 11-spiders panel)

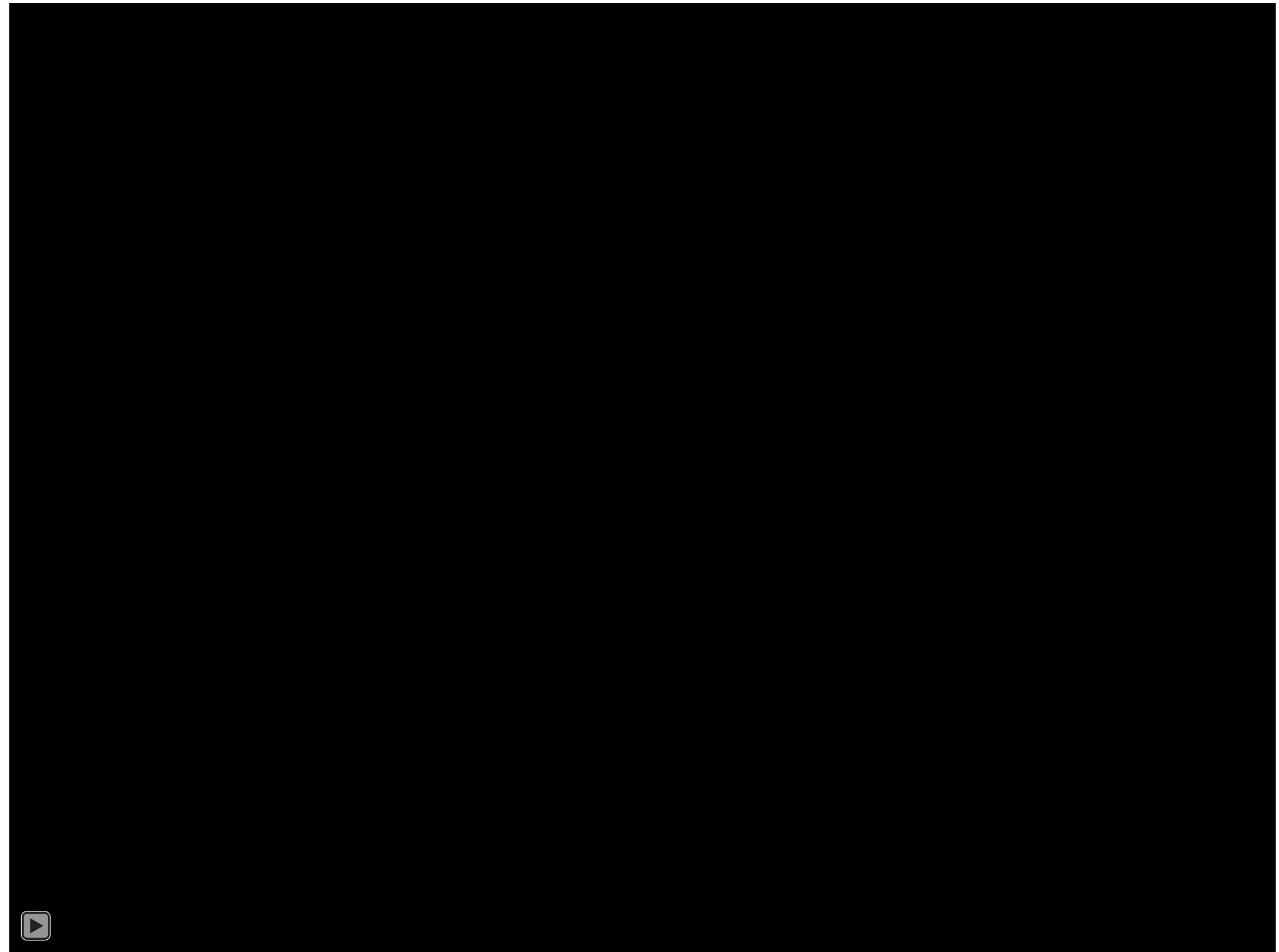

JELLO CHANDELIER
SUMMER 2010

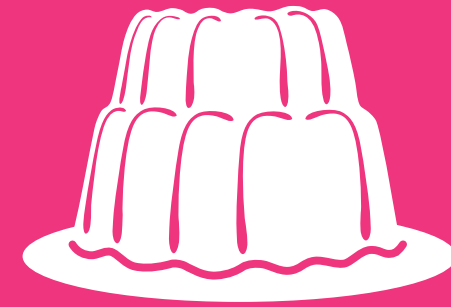

KEEP
CALM
AND
WOBBLE
ON

GSS JELL-O MOLD DESIGN COMPETITION
26 JUNE 2010





LAMP SKIRT
FALL 2009



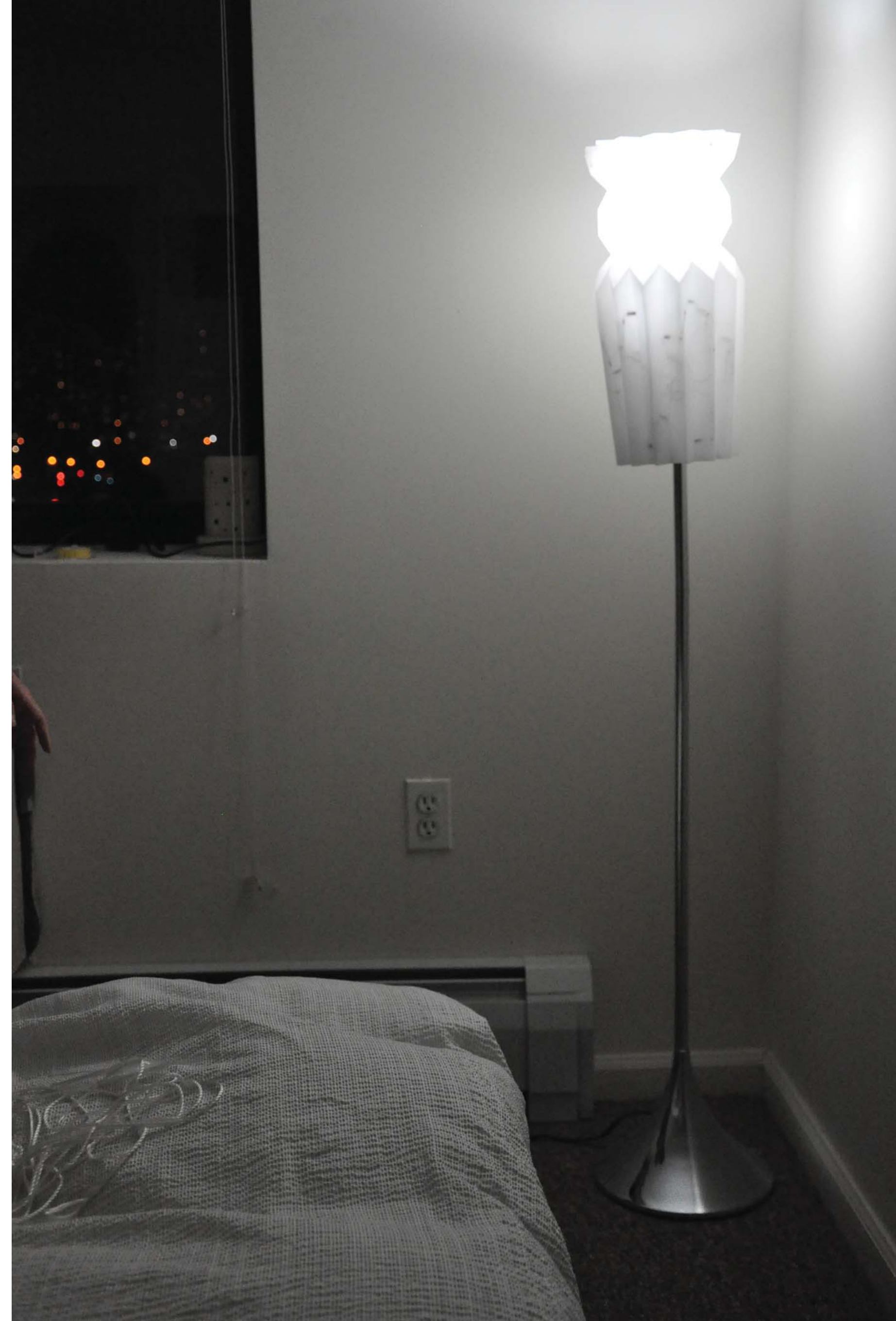

T. LEESER'S STUDIO
@COLUMBIA U.
SUMMER 2010





CIVIC BAILOUT
FALL 2008 - SPRING 2009
& WINTER 2009

NEW YORK CITY : CIVIC BAILOUT



CRISIS FRONTS: COGNITIVE INFRASTRUCTURES

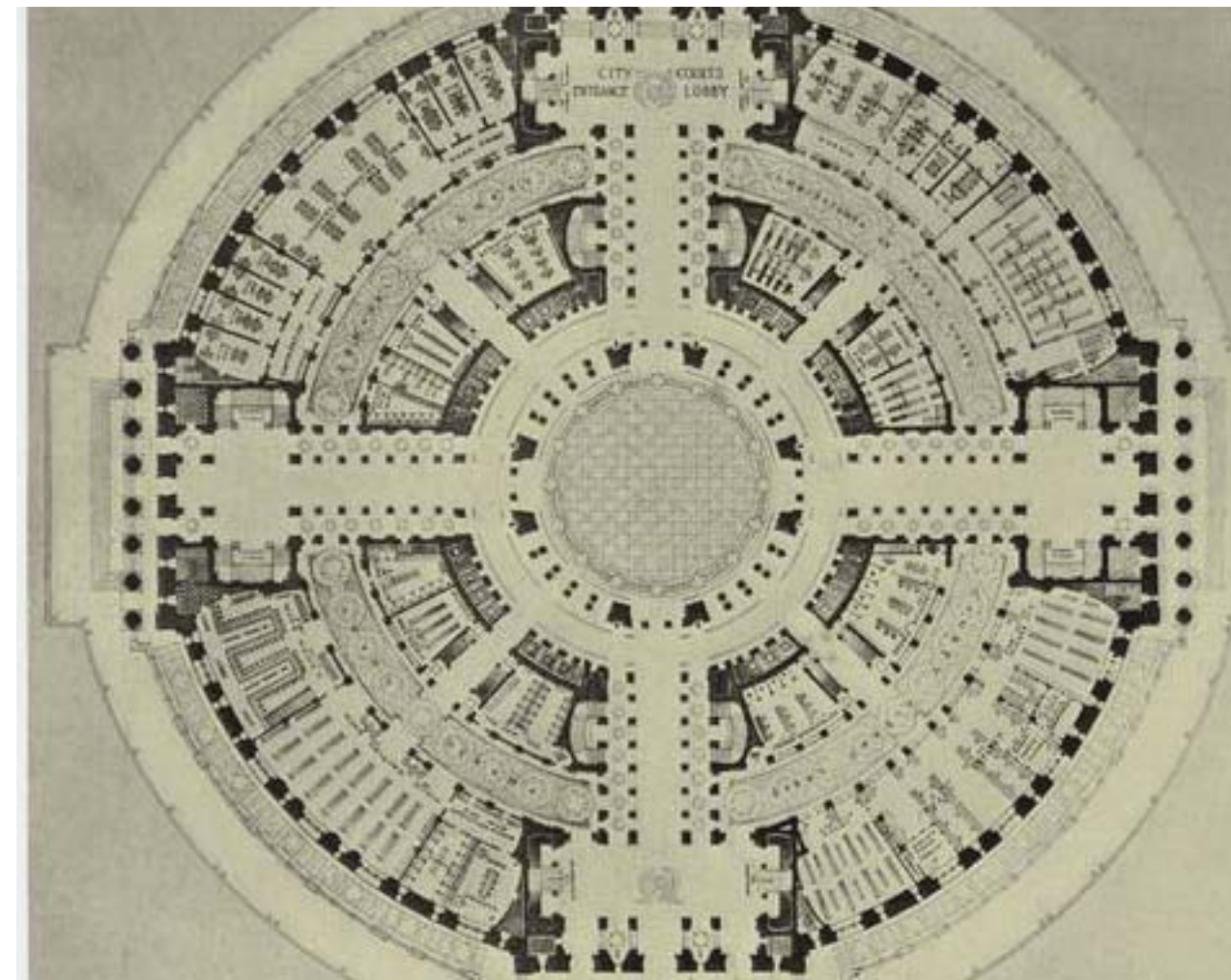

CONVENTIONAL CIVIC SPACE
FOLEY SQUARE

NEW YORK CITY : CIVIC BAILOUT

COGNITIVE INFRASTRUCTURES

CRISIS FRONTS:

S CAFFOLD

LATENT , DEPLOYABLE , MOBILE , MEDIATOR , REHABILITATES , BUFFER BETWEEN CITY AND CITIZENS

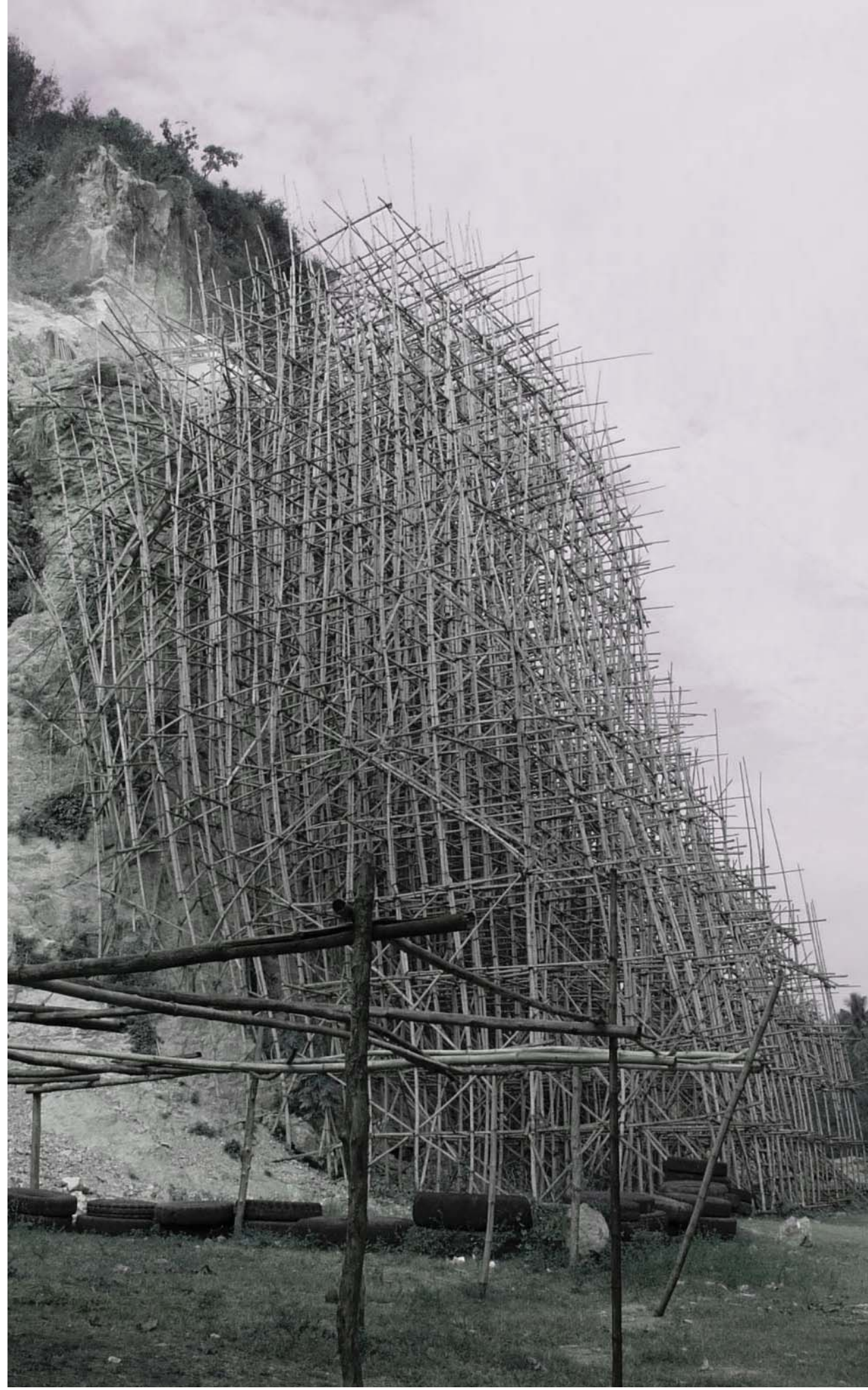

context

NEW YORK CITY : CIVIC BAILOUT

COGNITIVE INFRASTRUCTURES

CRISIS FRONTS:

CONTEXTUAL INPUTS

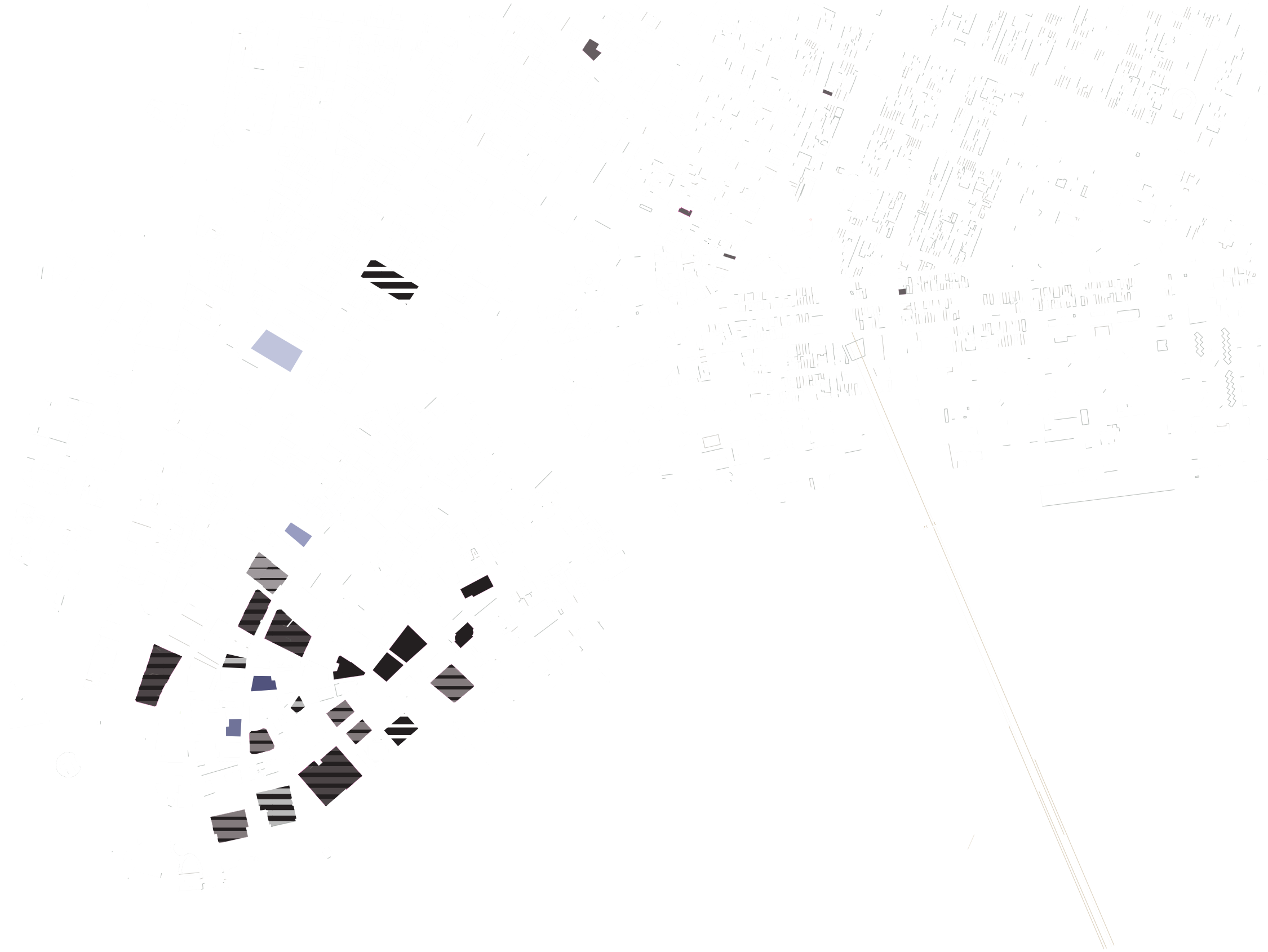

BAILOUT

- AIG - \$40,000million (with \$30Billion to come)
- JPMorgan Chase - \$25,000million
- First American International - \$17million
- Goldman Sachs - \$10,000million
- Morgan Stanley - \$10,000 million
- Lehman Brothers (defunct)

VACANCY

- 75%Vacancy - 67 Broad St.
- 51% - 80 Broad St.
- 41% - 140 Broadway
- 16% - 100 Church St.

LAYOFFS

- Citibank - 52,000
- Bank of America - 35,000
- Lehman - 24,000
- JP Morgan - 9,200
- Goldman Sach - 3,300
- Morgan Stanley - 1,500
- Barclays - 600

NEW YORK CITY: CIVIC BAILOUT



CRISIS FRONTS: COGNITIVE INFRASTRUCTURES



CIVIC WITHIN THE PUBLIC
FOLEY SQUARE

Bradley Rothenberg | Joanna Cheung

civic colonization

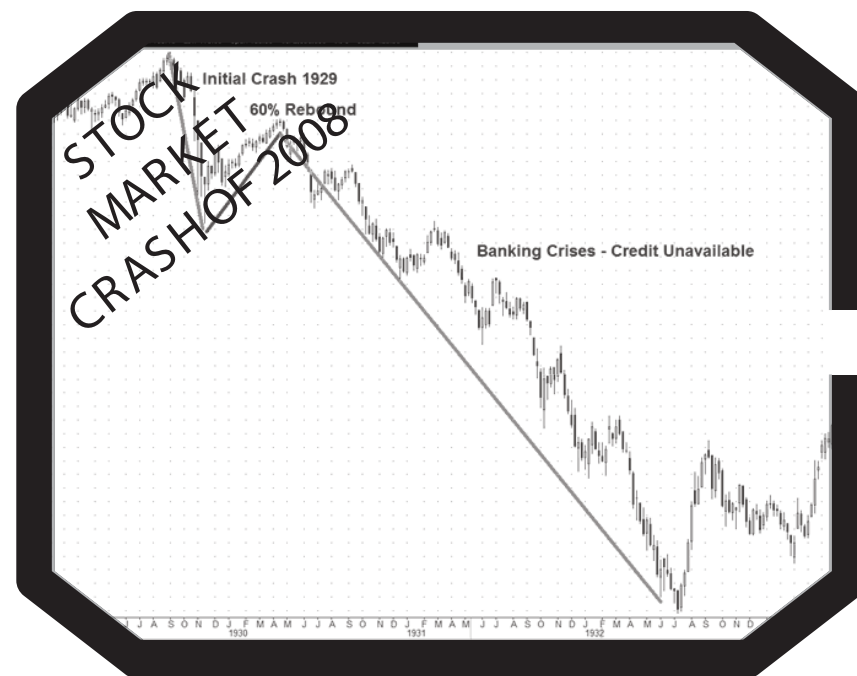

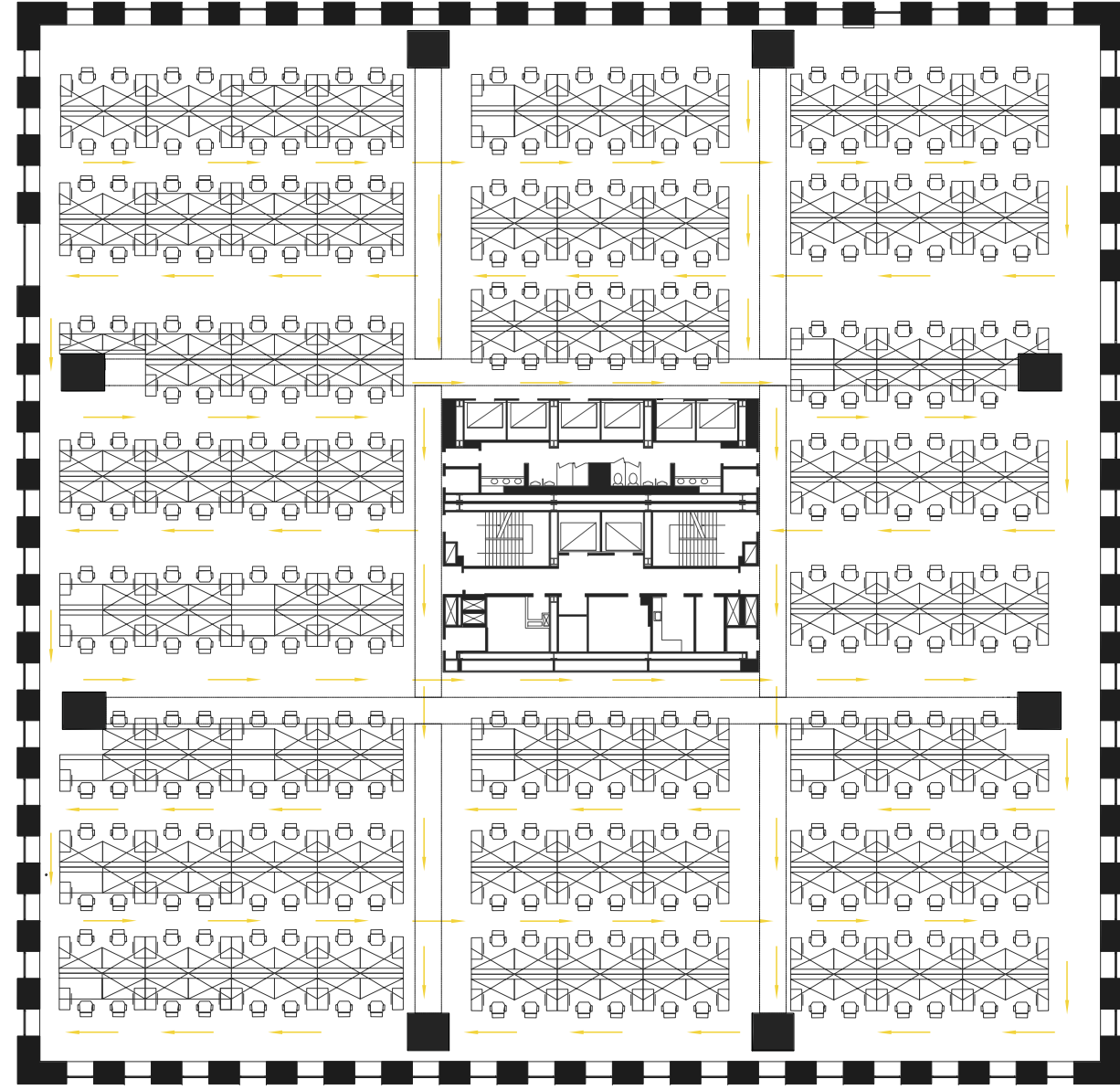

modernist

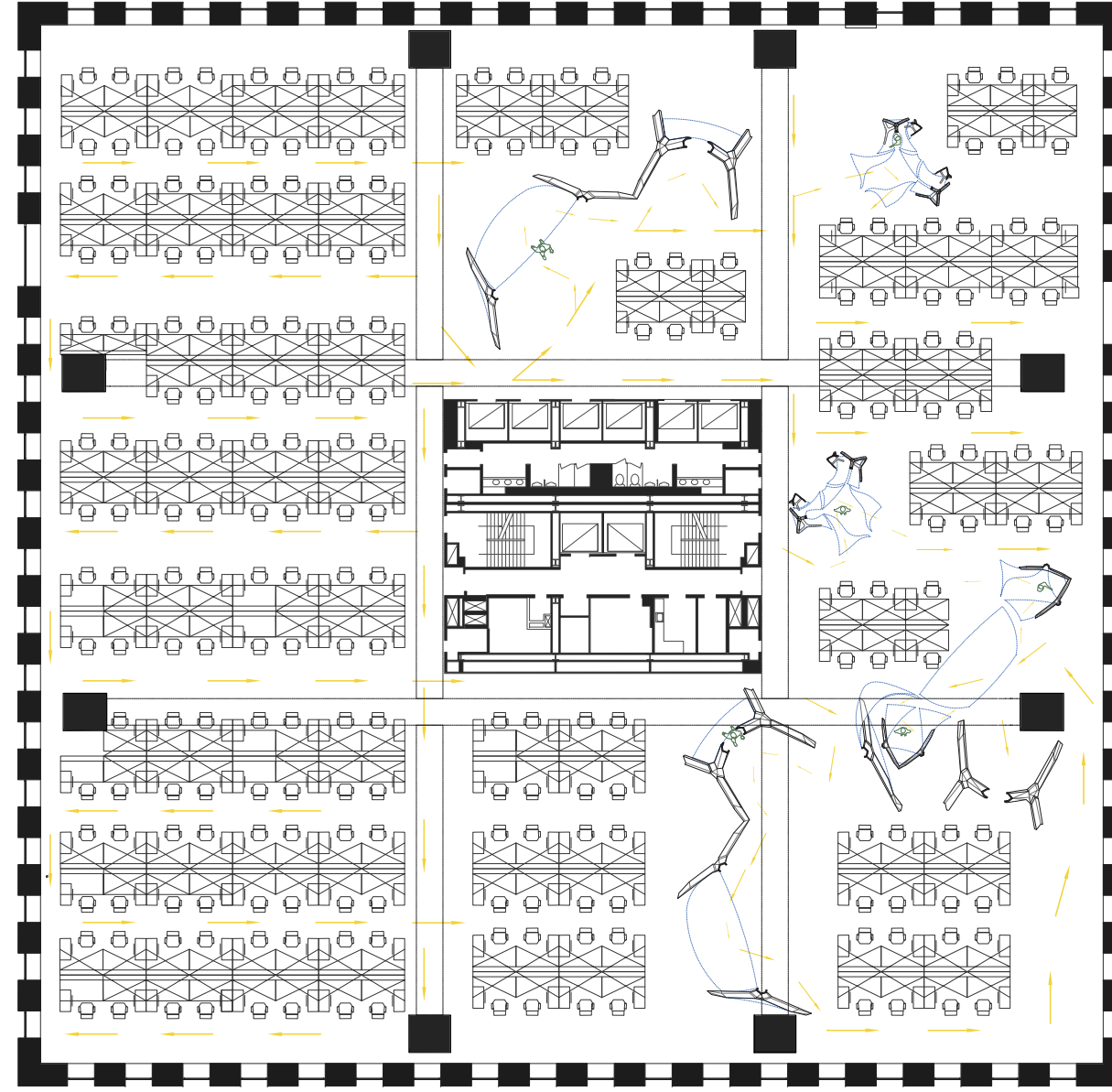

dynamic partitions

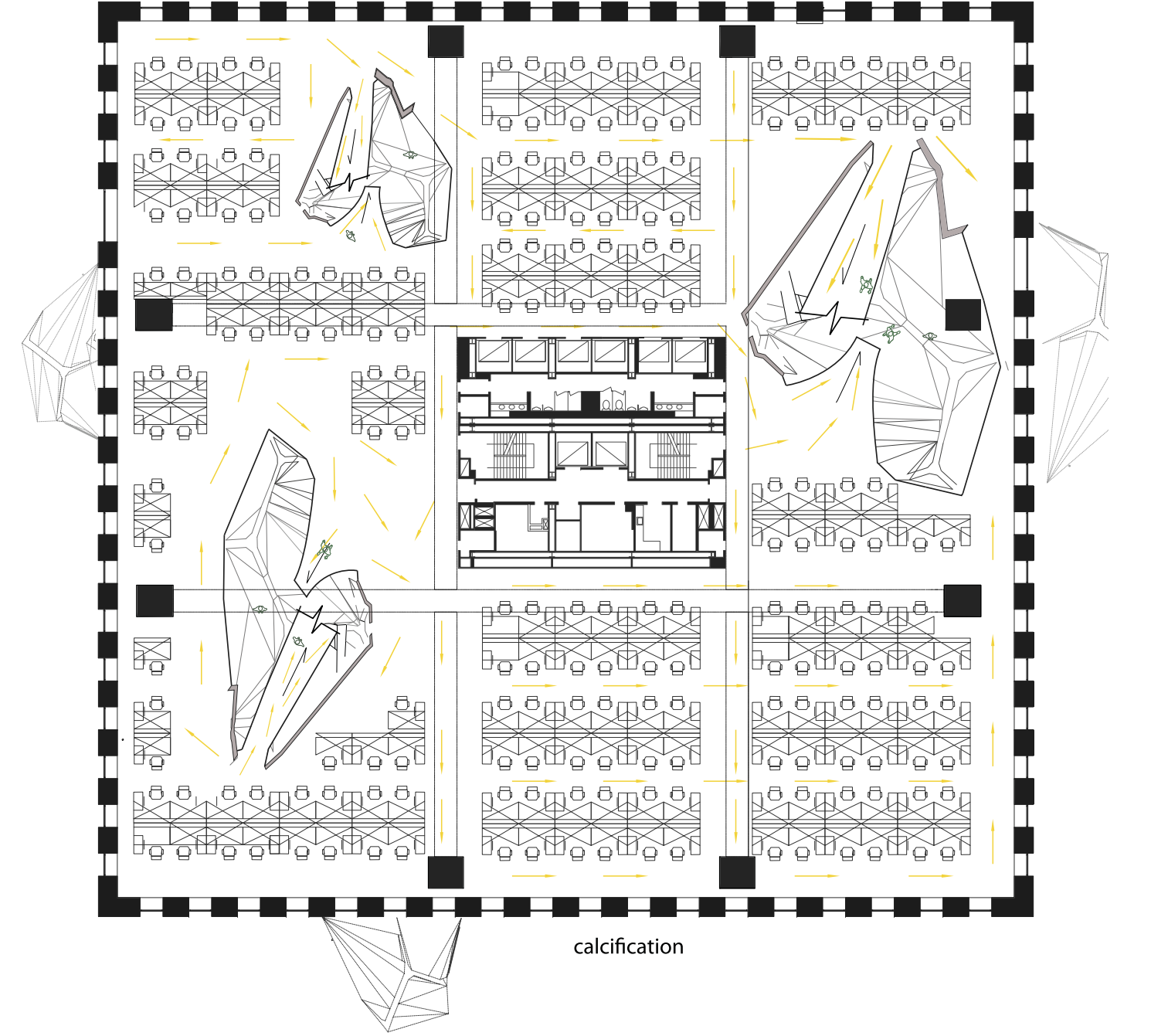

calcification

NEW YORK CITY: CIVIC BAILOUT

COGNITIVE INFRASTRUCTURES

CRISIS FRONTS:

DISPERSED EDGE CONDITIONS FOR AMBIENT AND
ENCLOSURE SURFS
Scaffold Moments

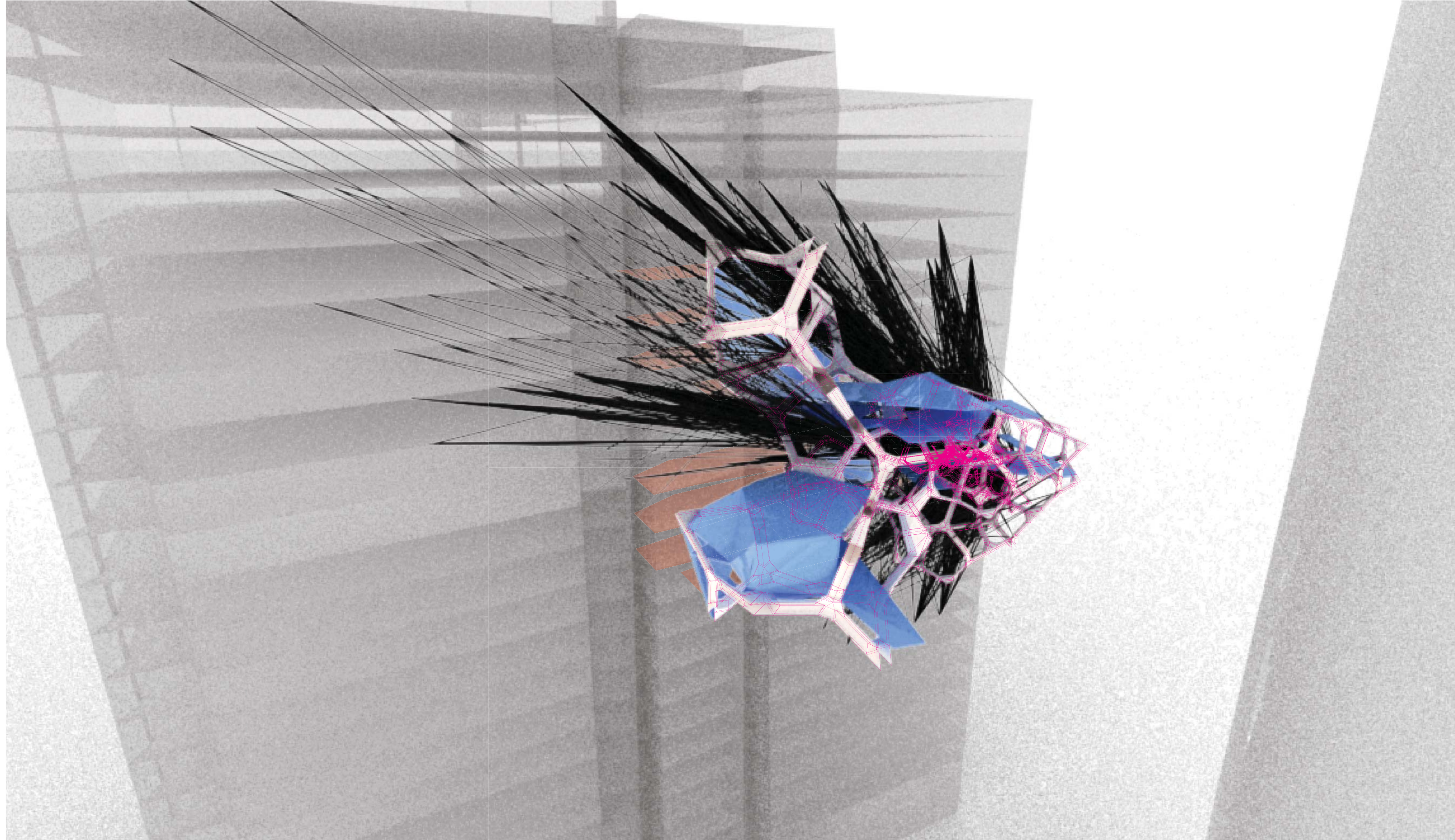

BRI DGING

Bradley Rothenberg | Joanna Cheung

NEW YORK CITY : CIVIC BAILOUT

COGNITIVE INFRASTRUCTURES

CRISIS FRONTS:

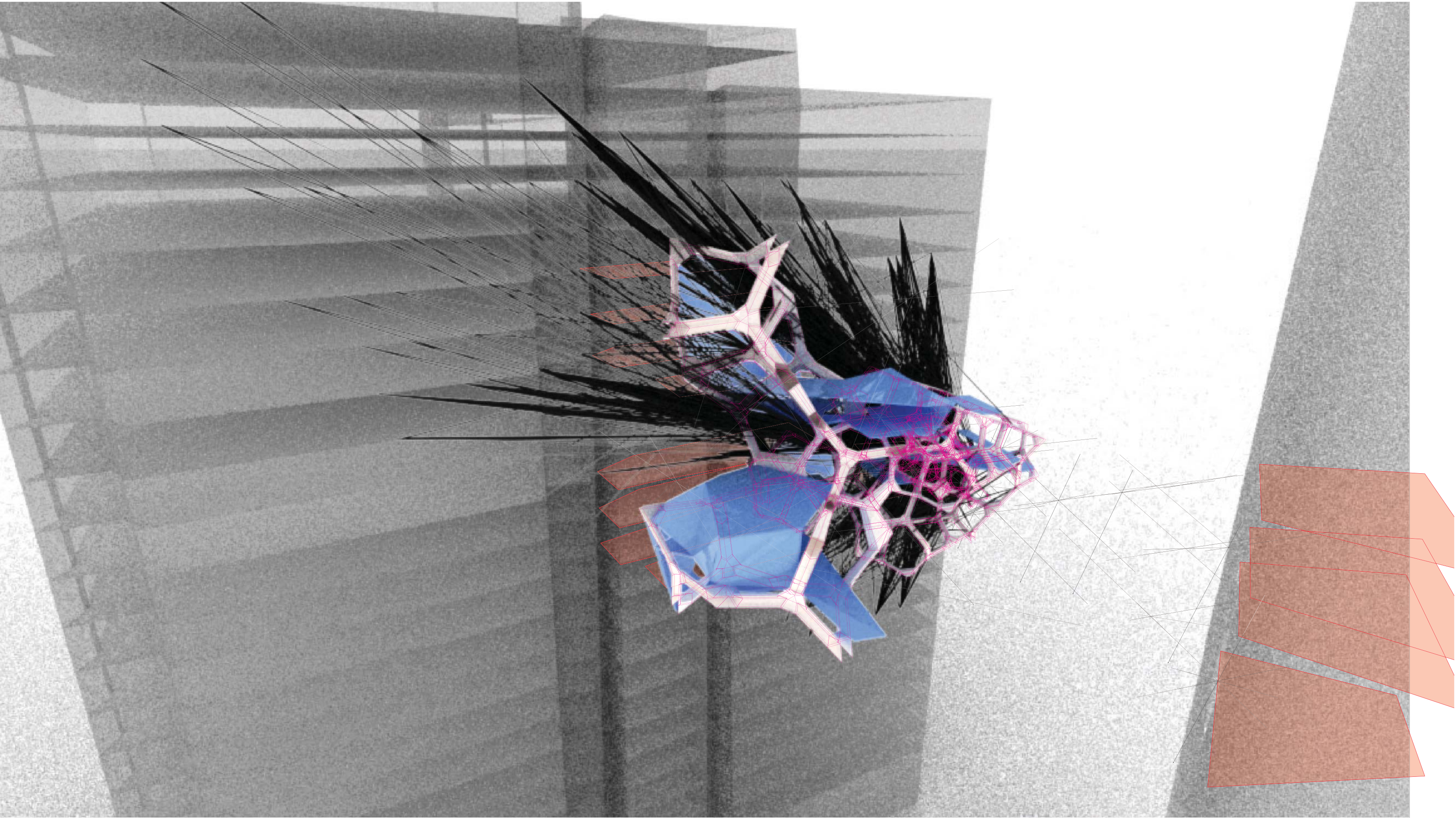

DISPIRSED EDGE CONDITION _NEW VACANCY IN RANGE

Scaffold Moments

BRI DGING

Bradley Rothenberg | Joanna Cheung

NEW YORK CITY : CIVIC BAILOUT

COGNITIVE INFRASTRUCTURES

CRISIS FRONTS:

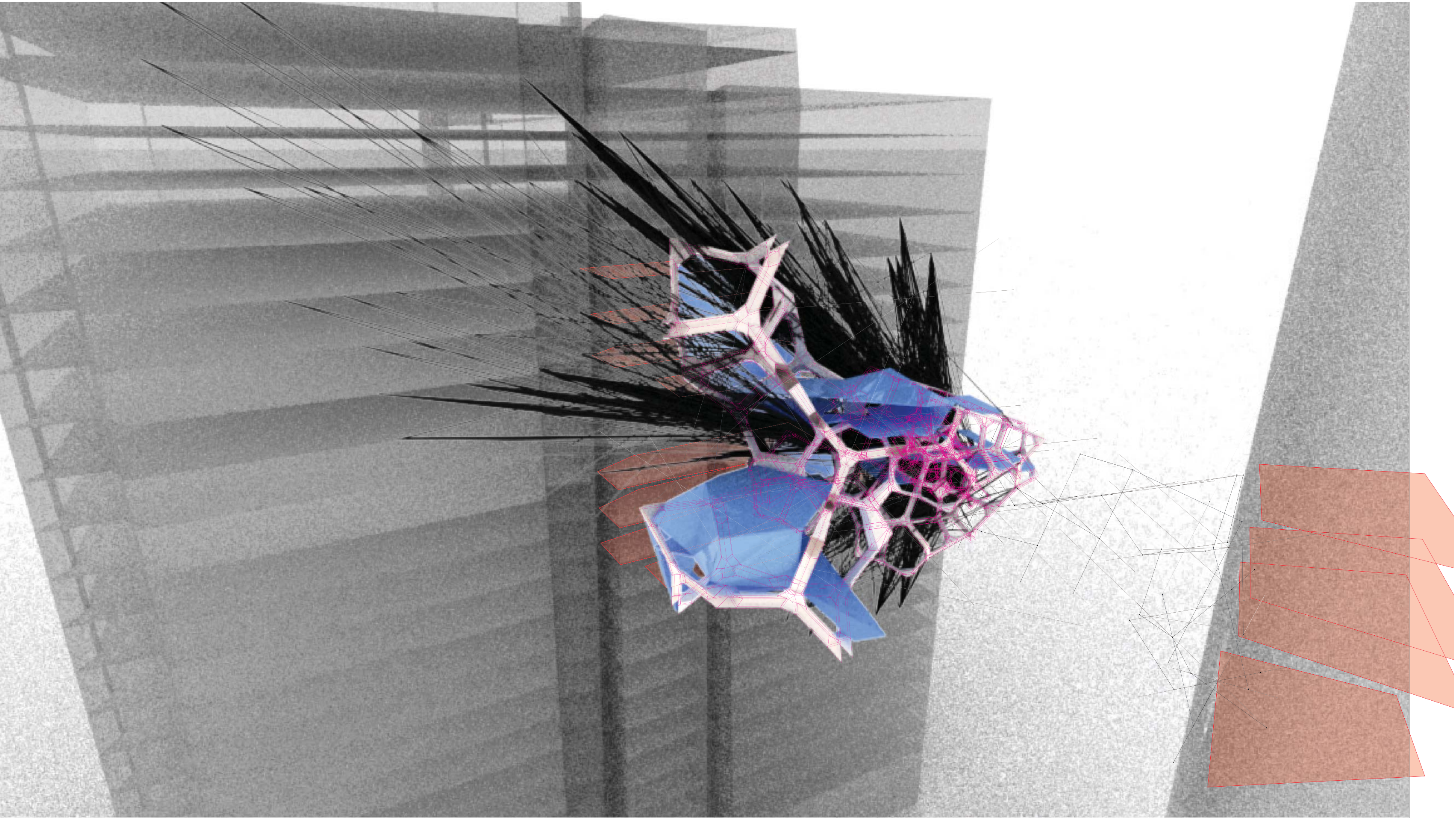

DISPIRSED EDGE CONDITION_FACE DIRECTIONS

Scaffold Moments

BRIDGING

Bradley Rothenberg | Joanna Cheung

NEW YORK CITY : CIVIC BAILOUT

COGNITIVE INFRASTRUCTURES

CRISIS FRONTS:

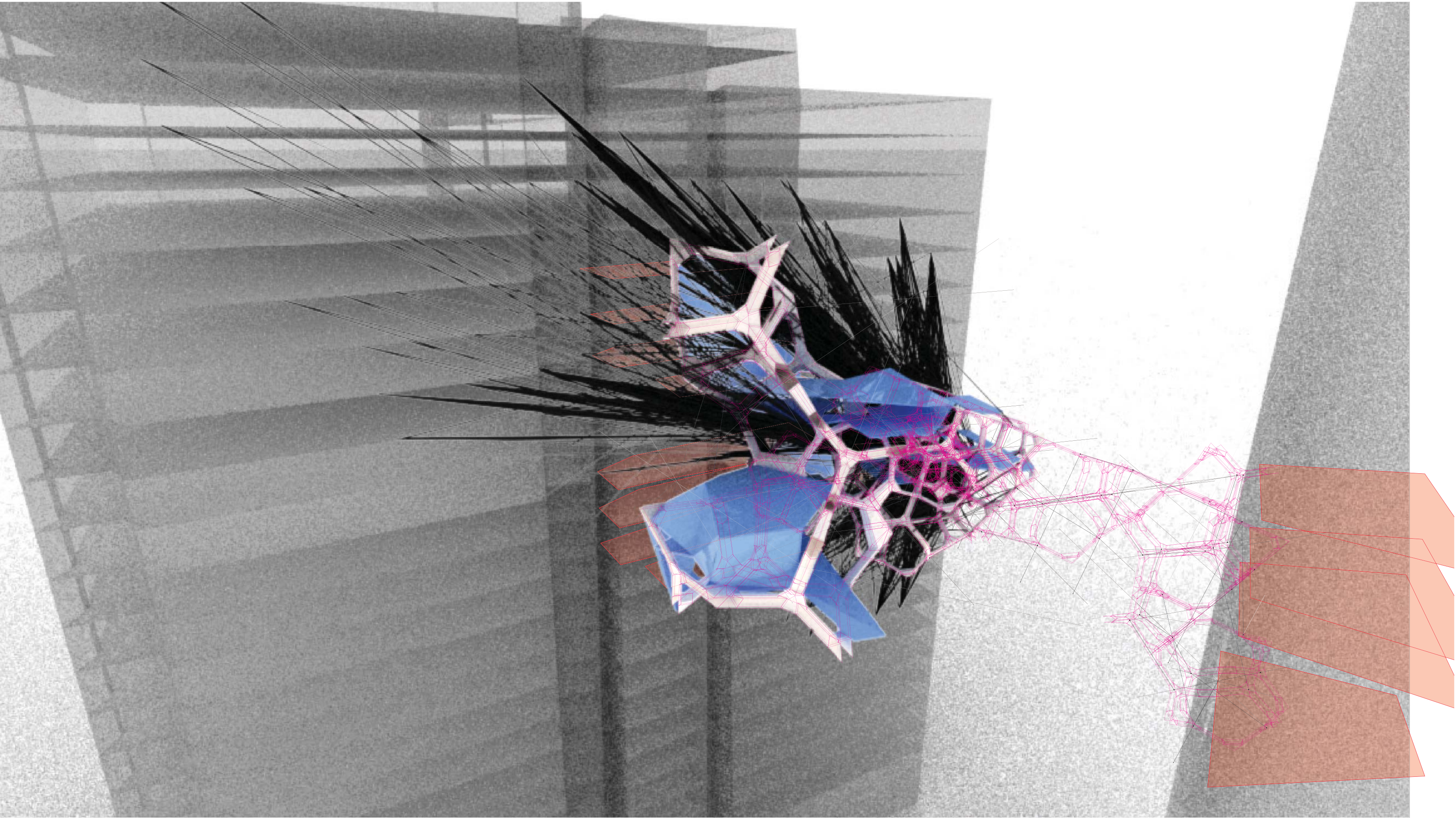

DISPIRSE D EDGE C ONDITION _SCAFFOL D DEPLOYE D

Scaffold Moments

BRI DGING

Bradley Rothenberg | Joanna Cheung

be a part of your cities future..
text CVMC to 41411

NEW YORK CITY : CIVIC BAILOUT

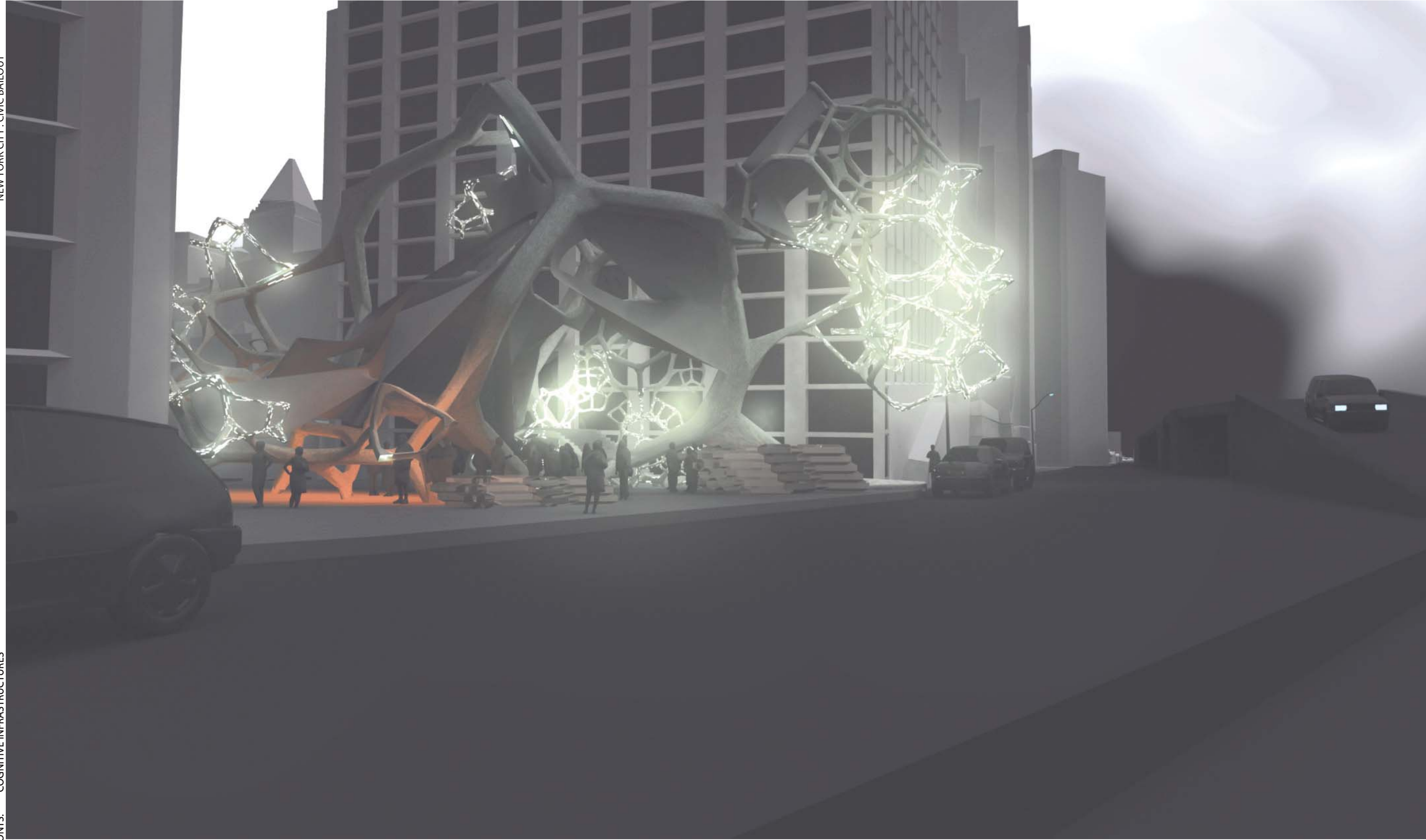

CRISIS FRONTS: COGNITIVE INFRASTRUCTURES

ACT ONE_P AVILLION AS A SITE OF INFORMAL CIVIC GATHERING

NEW YORK CITY: CIVIC BAILOUT

CRISIS FRONTS: COGNITIVE INFRASTRUCTURES

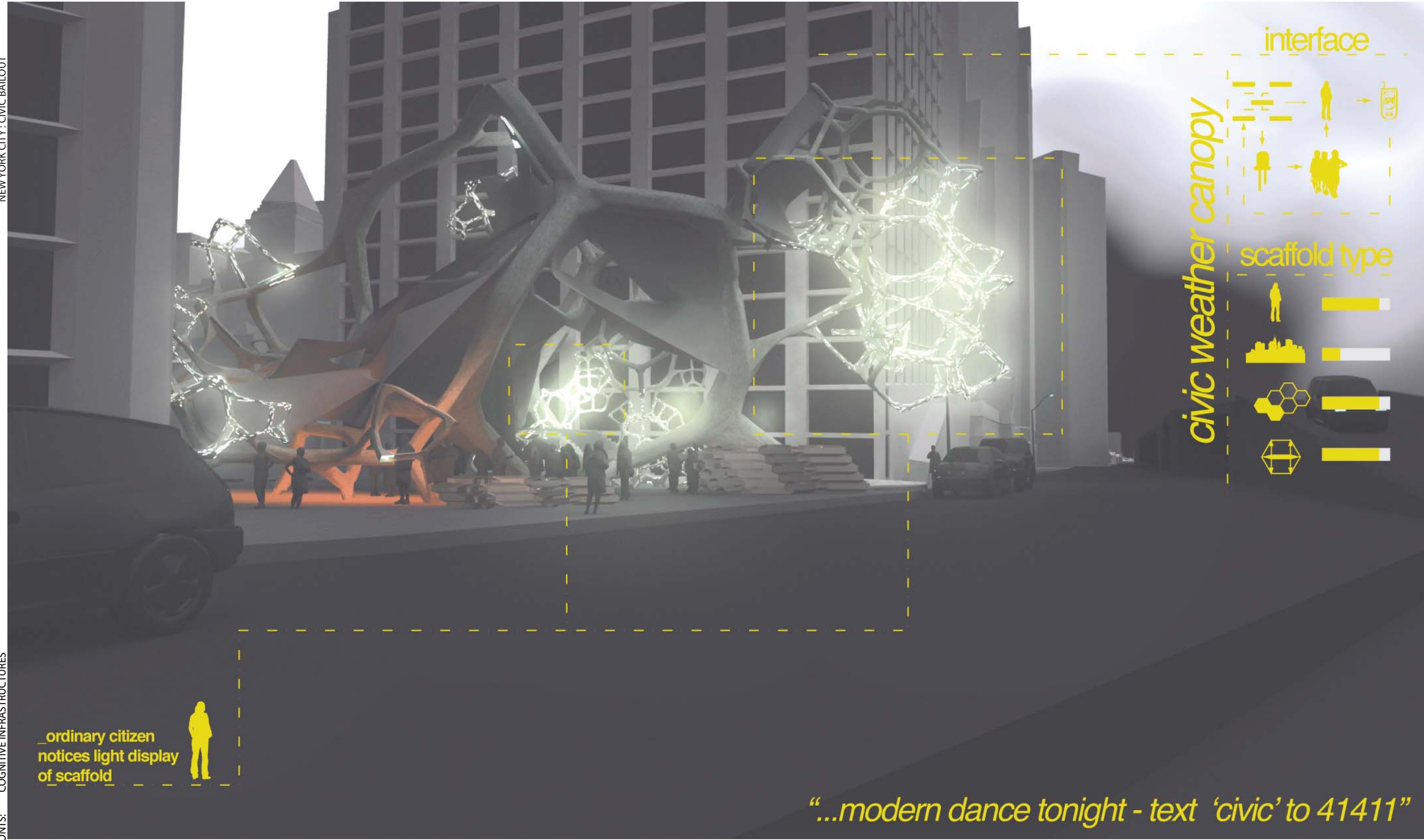

ACT ONE_P AVILLION AS A SITE OF INFORMAL CIVIC GATHERING

NEW YORK CITY : CIVIC BAILOUT



CRISIS FRONTS: COGNITIVE INFRASTRUCTURES

ACT ONE_P AVILLION AS A SITE OF INFORMAL CIVIC GATHERING

NEW YORK CITY: CIVIC BAILOUT

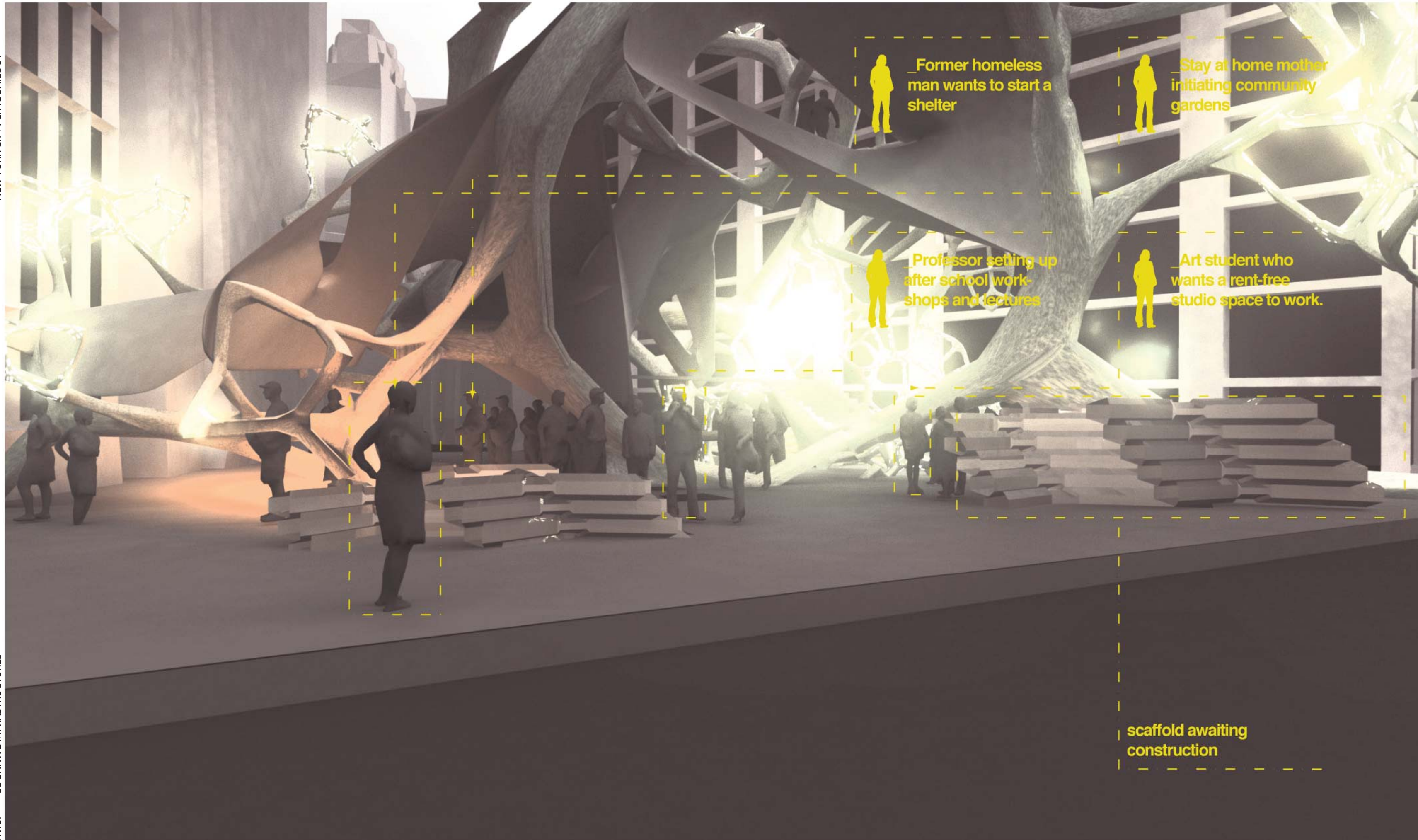

Former homeless man wants to start a shelter

Stay at home mother initiating community gardens

Professor setting up after school workshops and lectures

Art student who wants a rent-free studio space to work.

scaffold awaiting construction

CRISIS FRONTS: COGNITIVE INFRASTRUCTURES

ACT ONE_P AVILLION AS A SITE OF INFORMAL CIVIC GATHERING

NEW YORK CITY : CIVIC BAILOUT



CRISIS FRONTS: COGNITIVE INFRASTRUCTURES

ACT ONE_P AVILLION AS A SITE OF INFORMAL CIVIC GATHERING

NEW YORK CITY : CIVIC BAILOUT



CRISIS FRONTS: COGNITIVE INFRASTRUCTURES

ACT ONE_P AVILLION AS A SITE OF INFORMAL CIVIC GATHERING

NEW YORK CITY: CIVIC BAILOUT

CRISIS FRONTS: COGNITIVE INFRASTRUCTURES

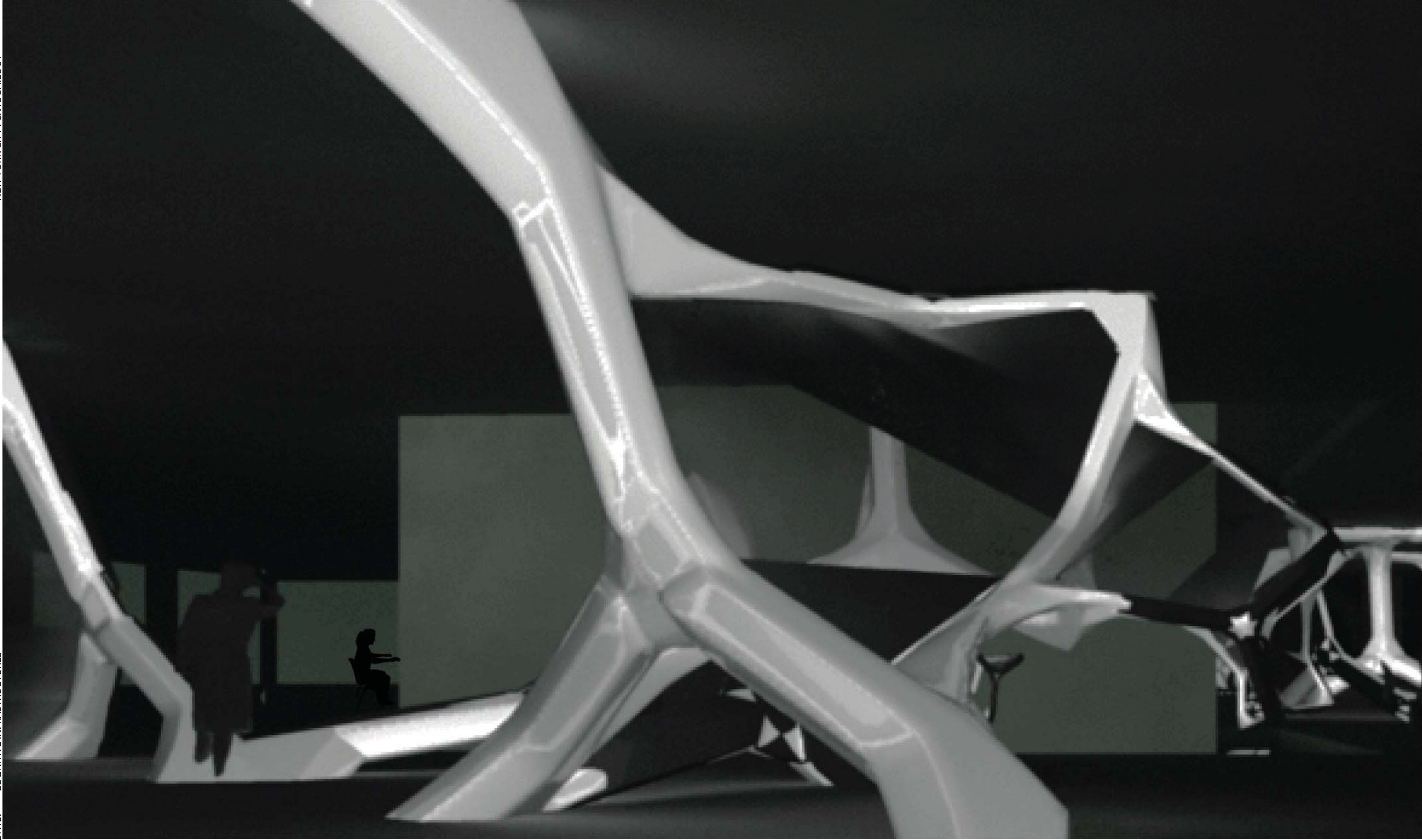

ACT THREE _PARTITION AS A MEDIATING THRESHOLD BETWEEN INSTITUTION AND CITIZEN

NEW YORK CITY : CIVIC BAILOUT

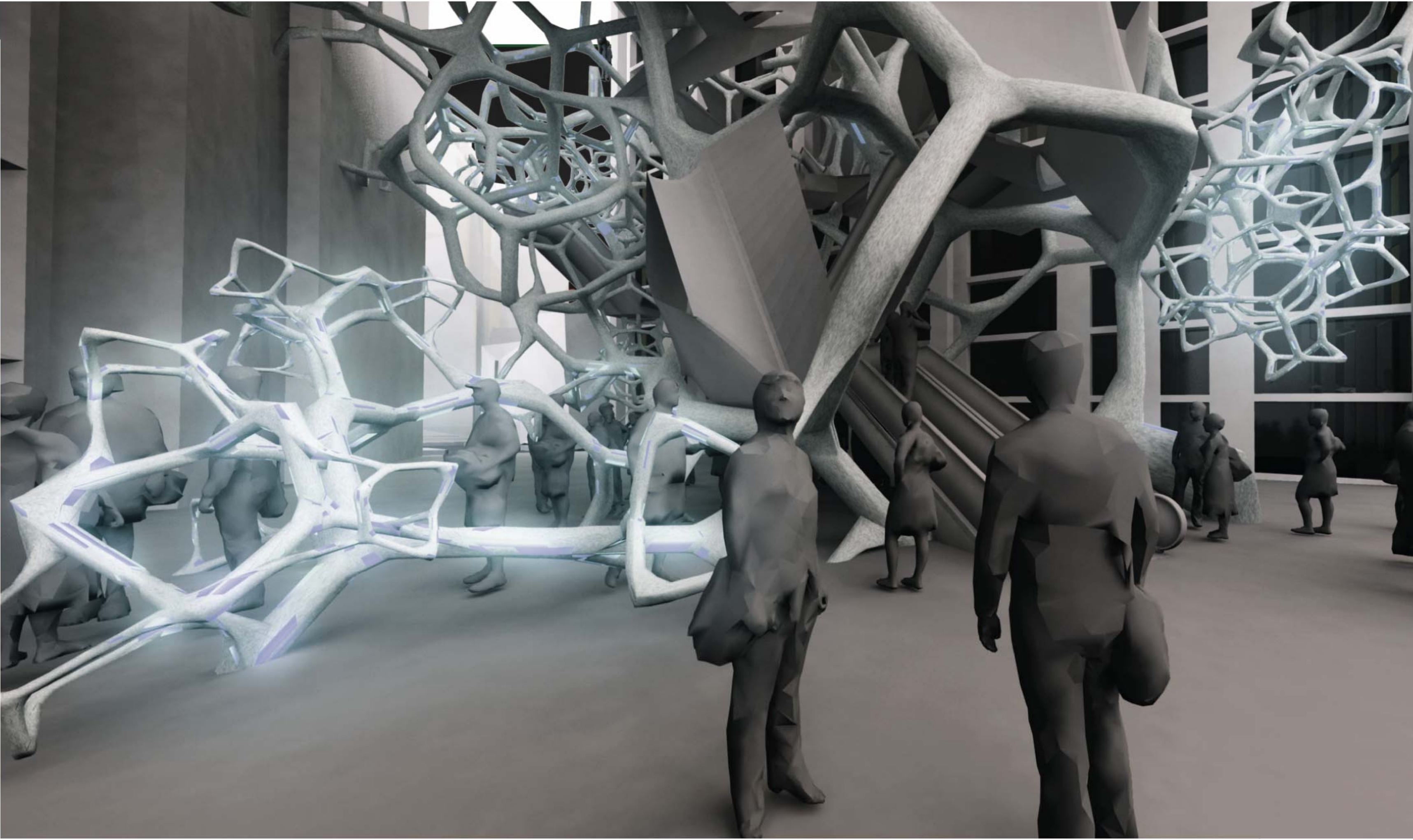

CRISIS FRONTS: COGNITIVE INFRASTRUCTURES

ACT FOUR_EXCESSIVE CONTINUITY TO SPUR CIVIC INTER ACTION BETWEEN INSTITUTION AND CITIZEN

NEW YORK CITY: CIVIC BAILOUT

CRISIS FRONTS: COGNITIVE INFRASTRUCTURES



ACT FOUR_EXCESSIVE CONTINUITY TO SPUR CIVIC INTER ACTION BETWEEN INSTITUTION AND CITIZEN

NEW YORK CITY: CIVIC BAILOUT

CRISIS FRONTS: COGNITIVE INFRASTRUCTURES

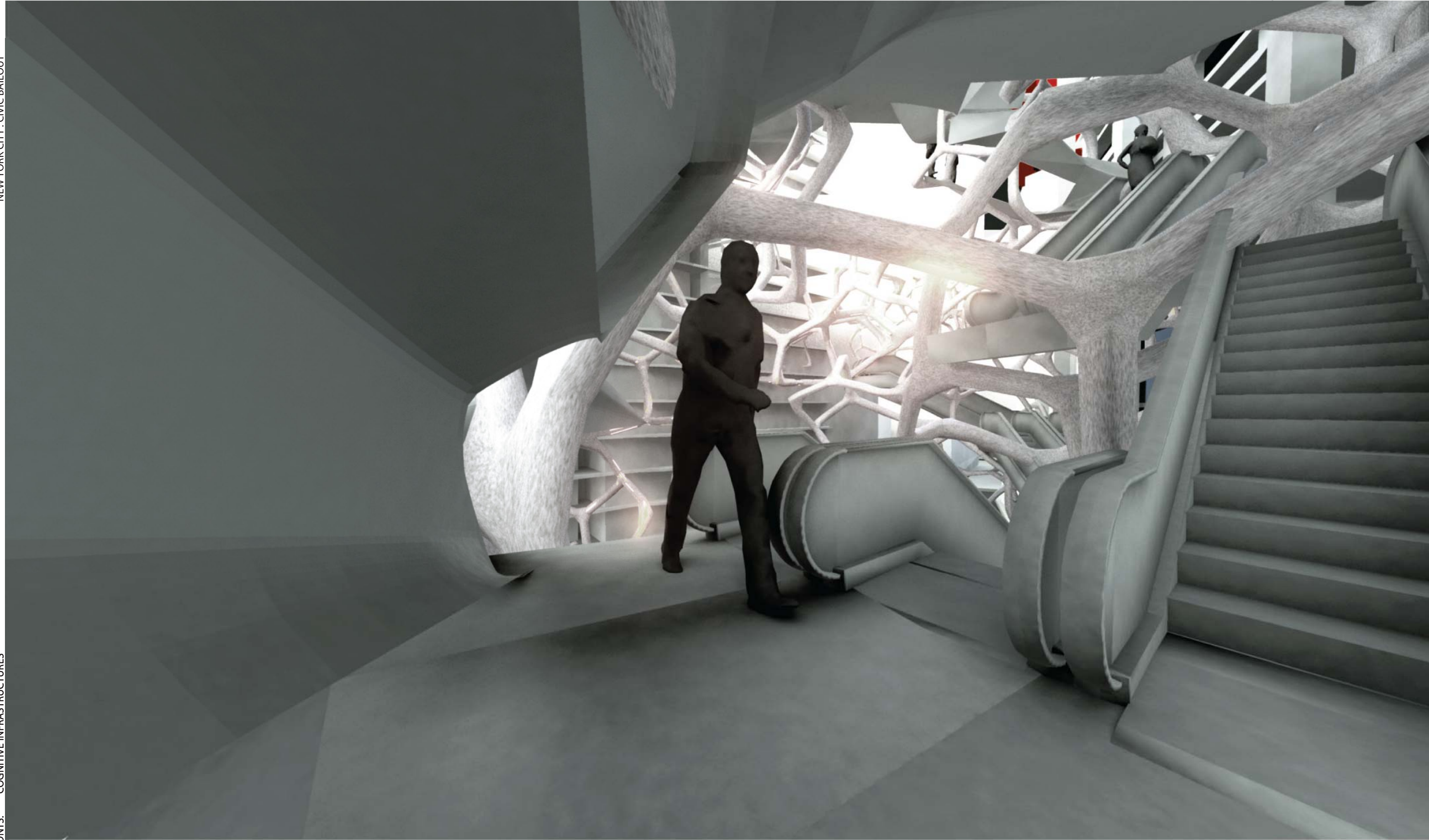

ACT FOUR_EXCESSIVE CONTINUITY TO SPUR CIVIC INTER ACTION BETWEEN INSTITUTION AND CITIZEN

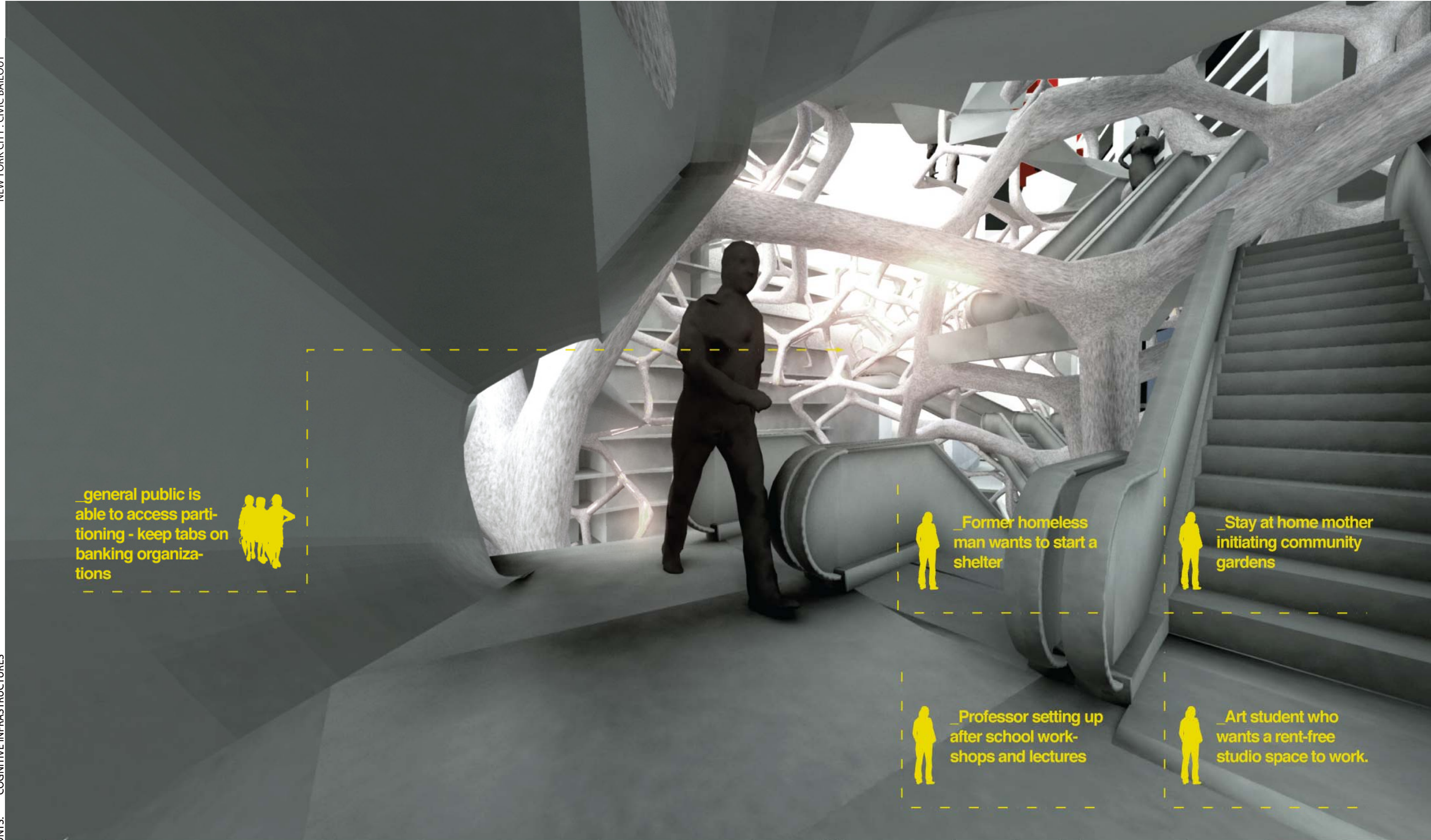

ACT FOUR _EXCESSIVE CONTINUITY TO SPUR CIVIC INTER ACTION BETWEEN INSTITUTION AND CITIZEN

NEW YORK CITY : CIVIC BAILOUT

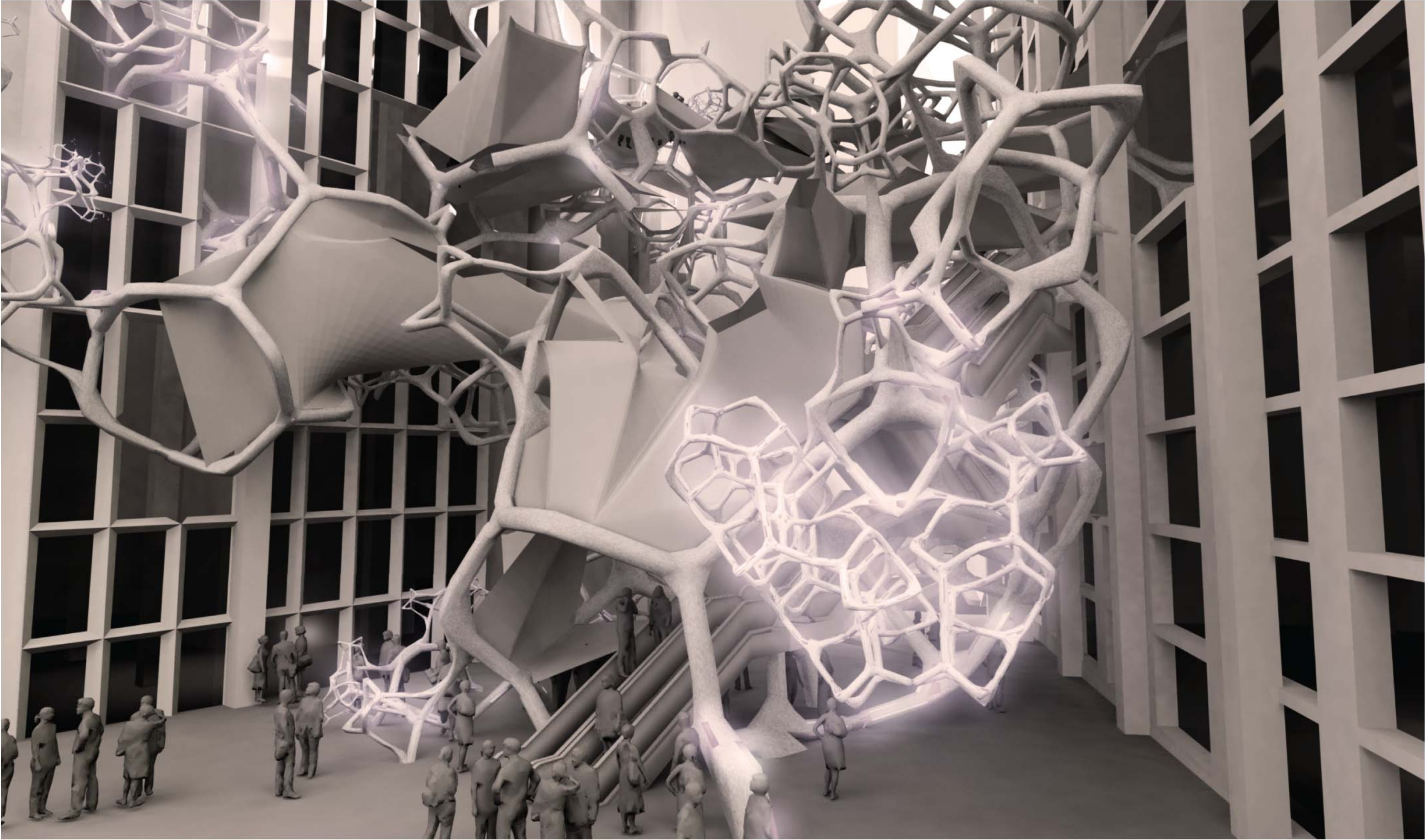

CRISIS FRONTS: COGNITIVE INFRASTRUCTURES

ACT FOUR_EXCESSIVE CONTINUITY TO SPUR CIVIC INTER ACTION BETWEEN INSTITUTION AND CITIZEN

NEW YORK CITY: CIVIC BAILOUT

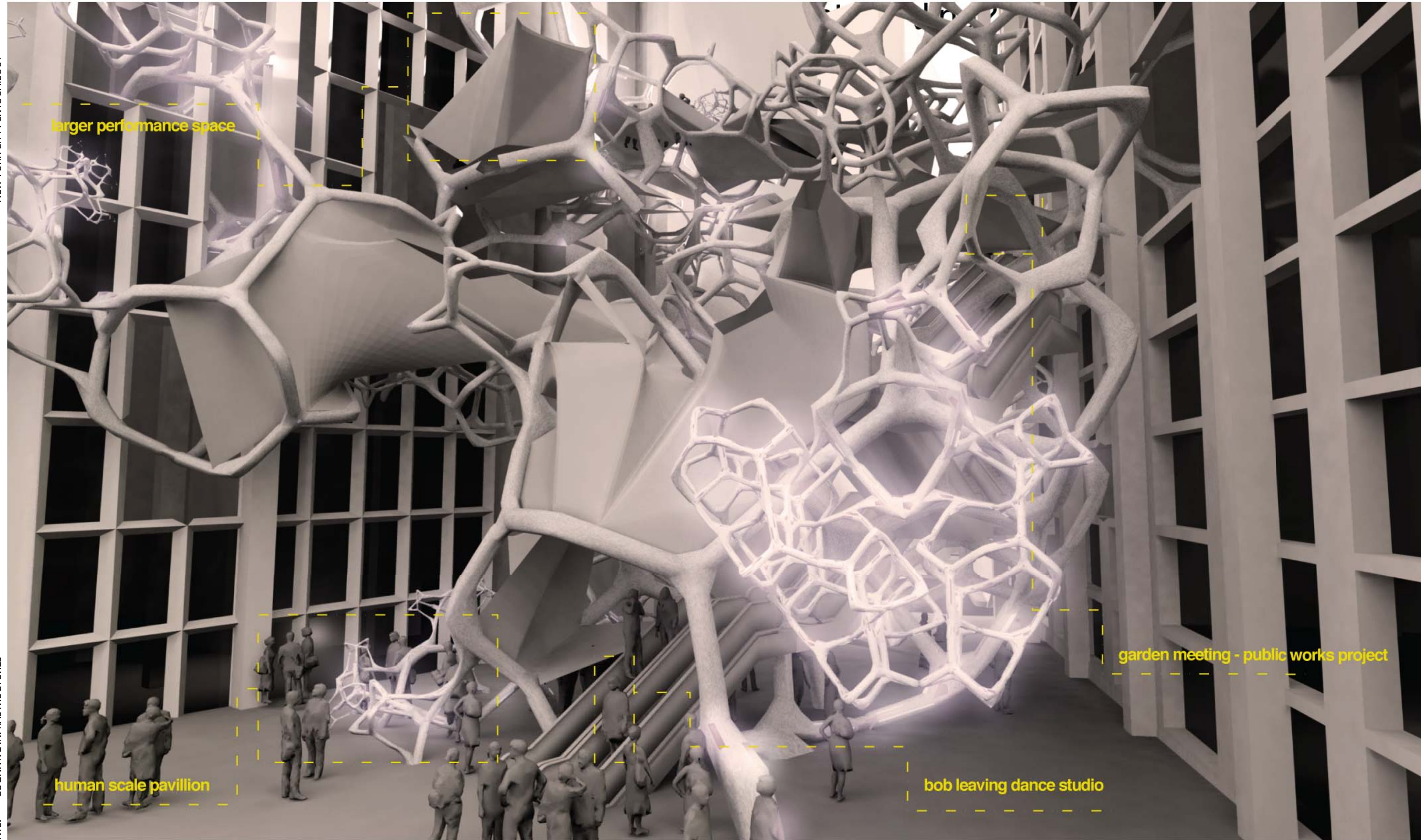

COGNITIVE INFRASTRUCTURES

CRISIS FRONTS:

ACT FOUR_EXCESSIVE CONTINUITY TO SPUR CIVIC INTER ACTION BETWEEN INSTITUTION AND CITIZEN

<http://vimeo.com/5595249>