

wa_3/32" snap-fit Assembly
Wishbones | Plates

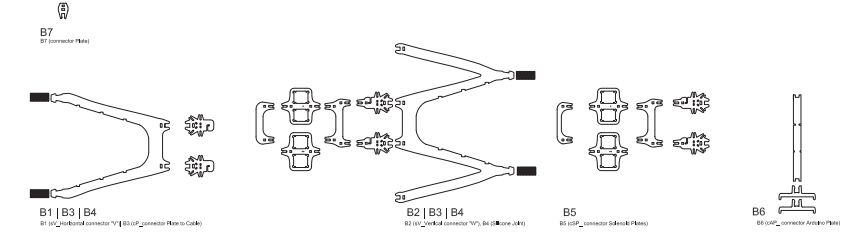

Cable Connection

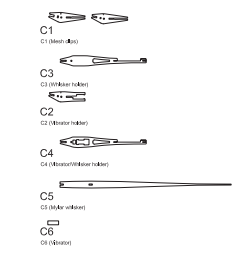

Whisker

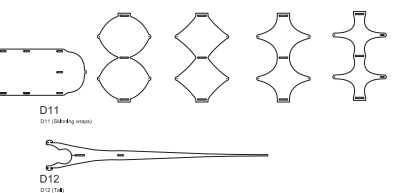
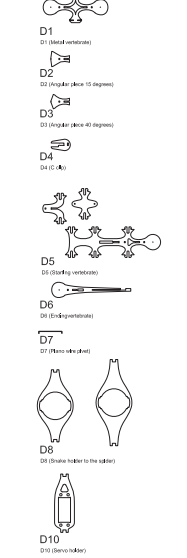

Snake

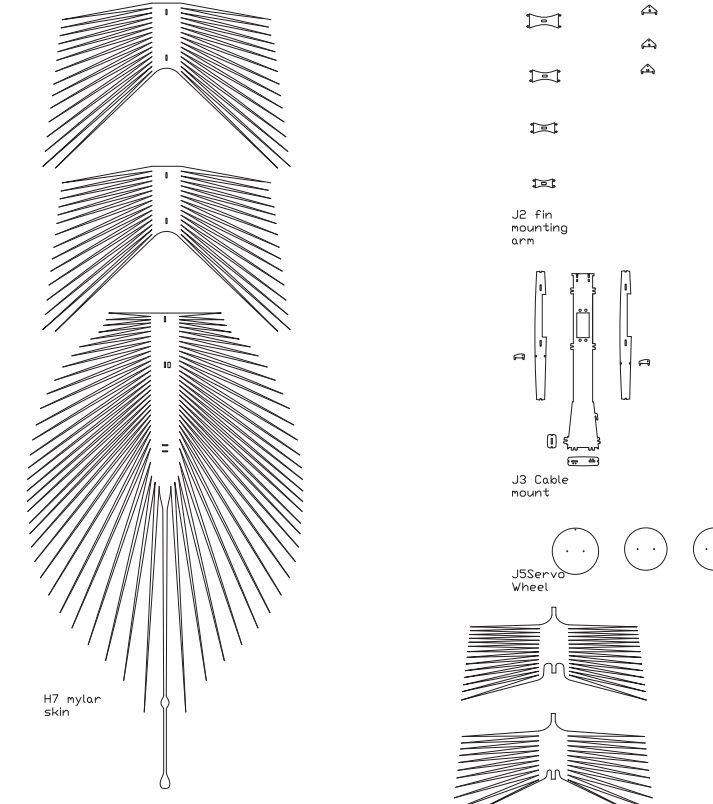
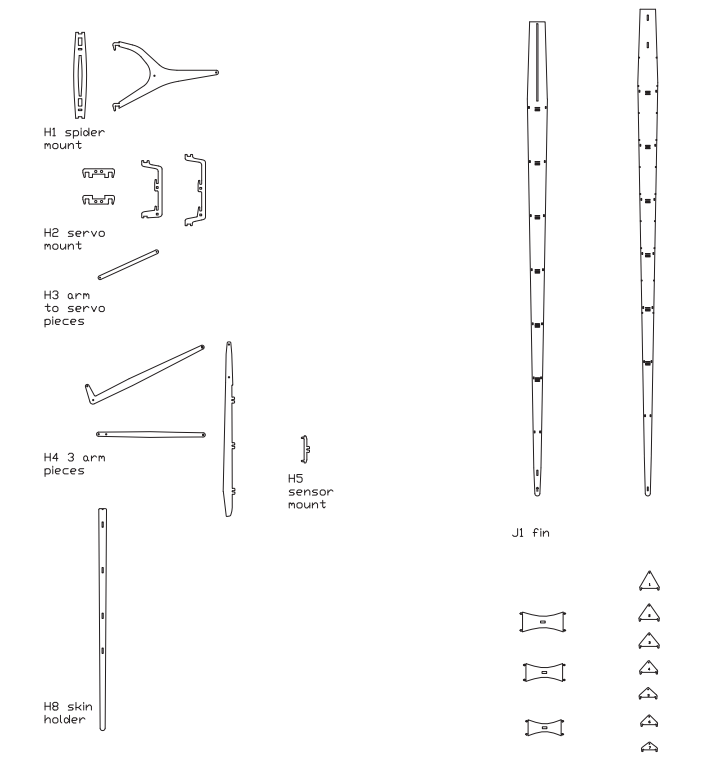

Whipping device

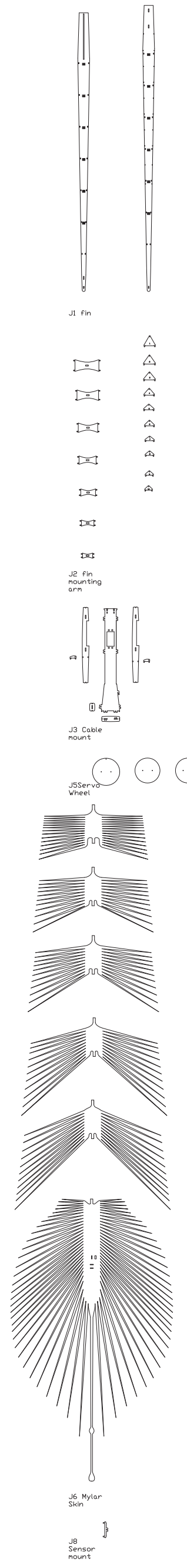

B

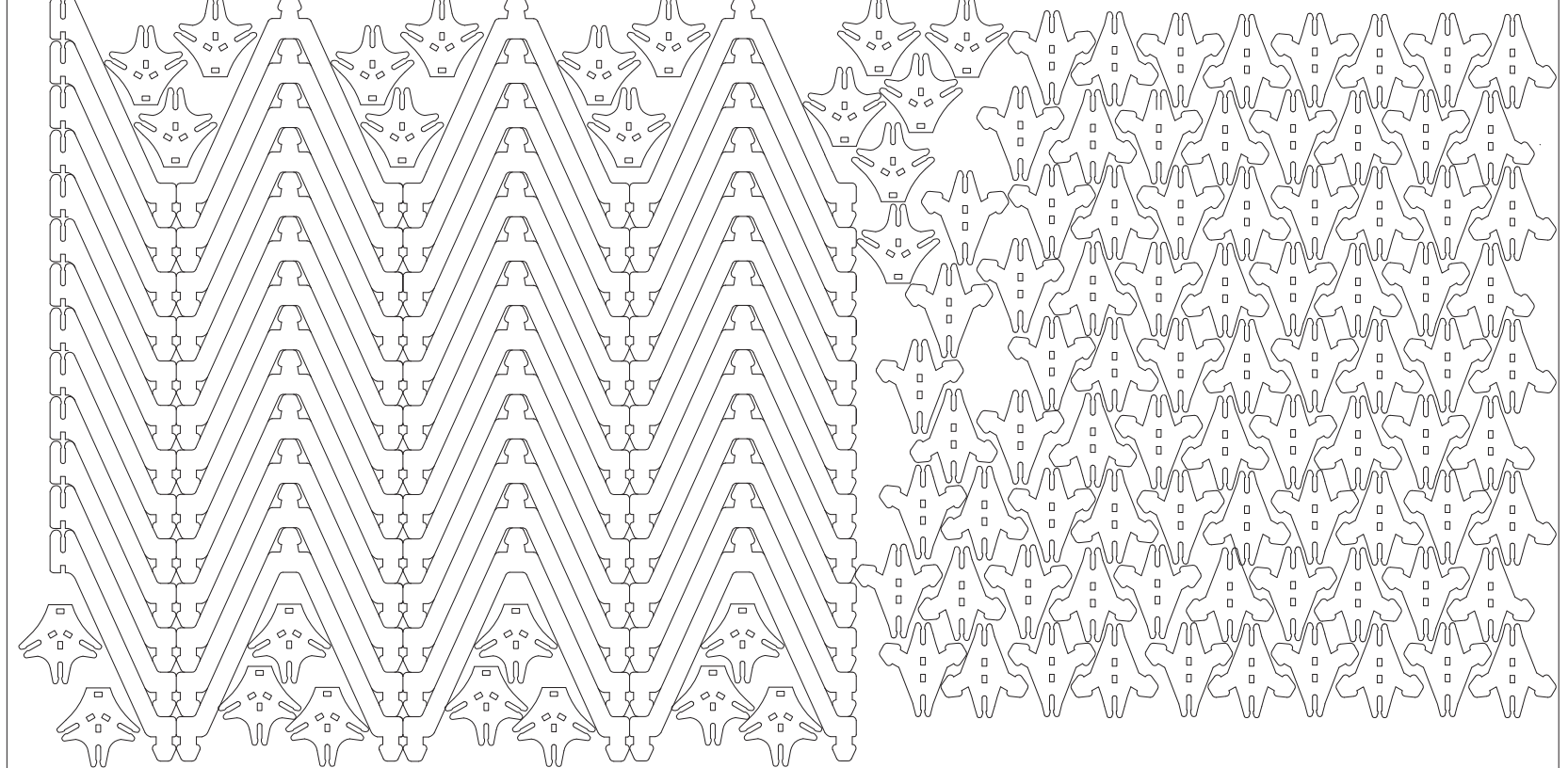
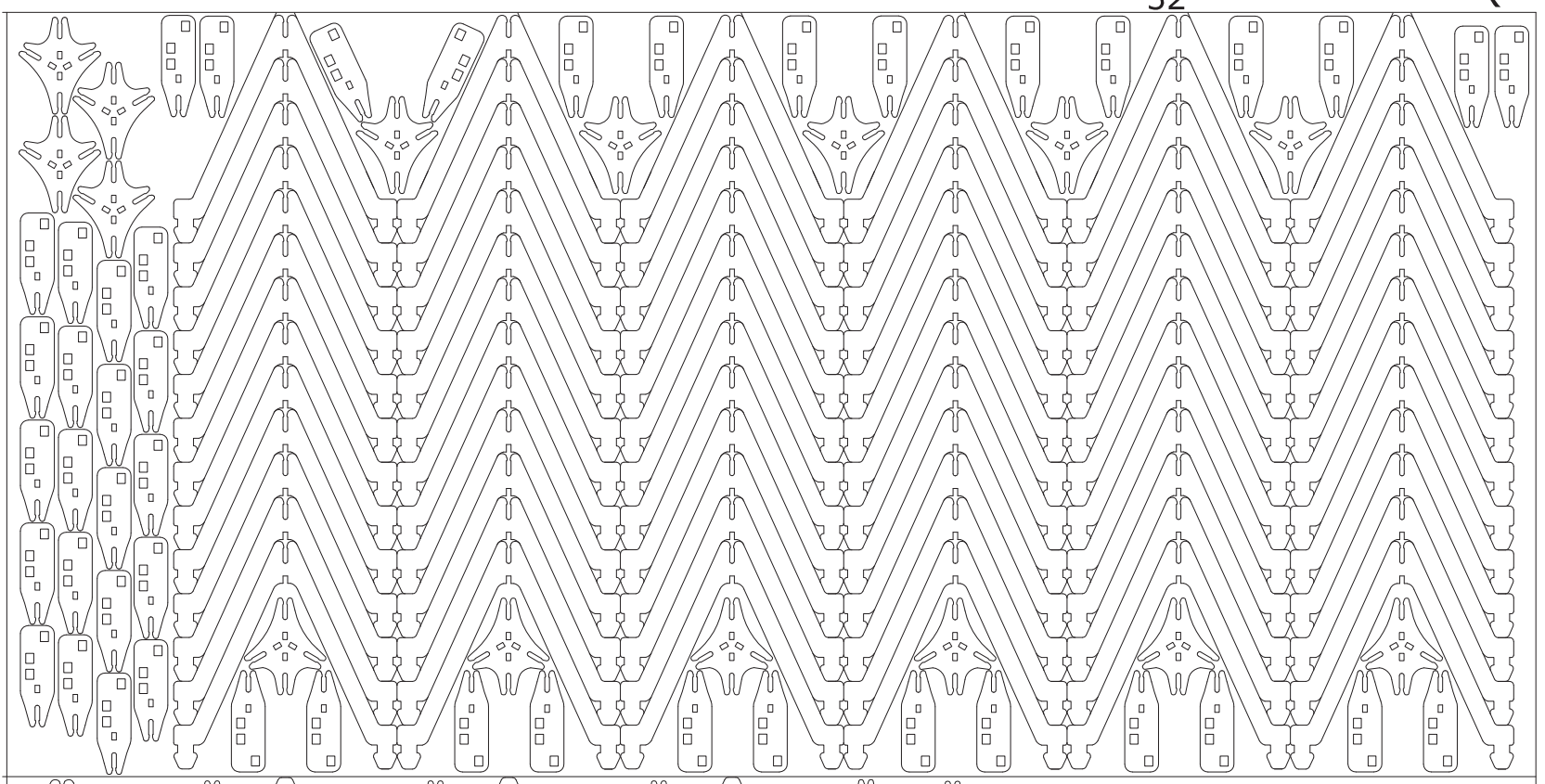

$\frac{3}{32}$ " 0.08" Plexi (x5 for 11-spiders panel)

D

AMPLE T SHEE
ME H TAX N M

$\frac{3}{32}$ " 0.08" Plexi (x1 for 11-spiders panel)