

SUPERFICIAL
SUPERGLOW

EXPERIENCE / MOOD

popMotion

Dani Eshed_Andres Colubri_Luis Palomares

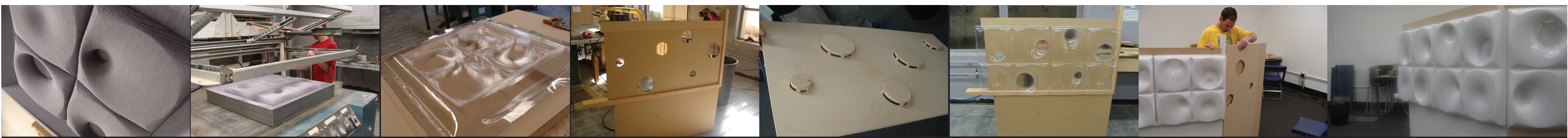

assembly sequence

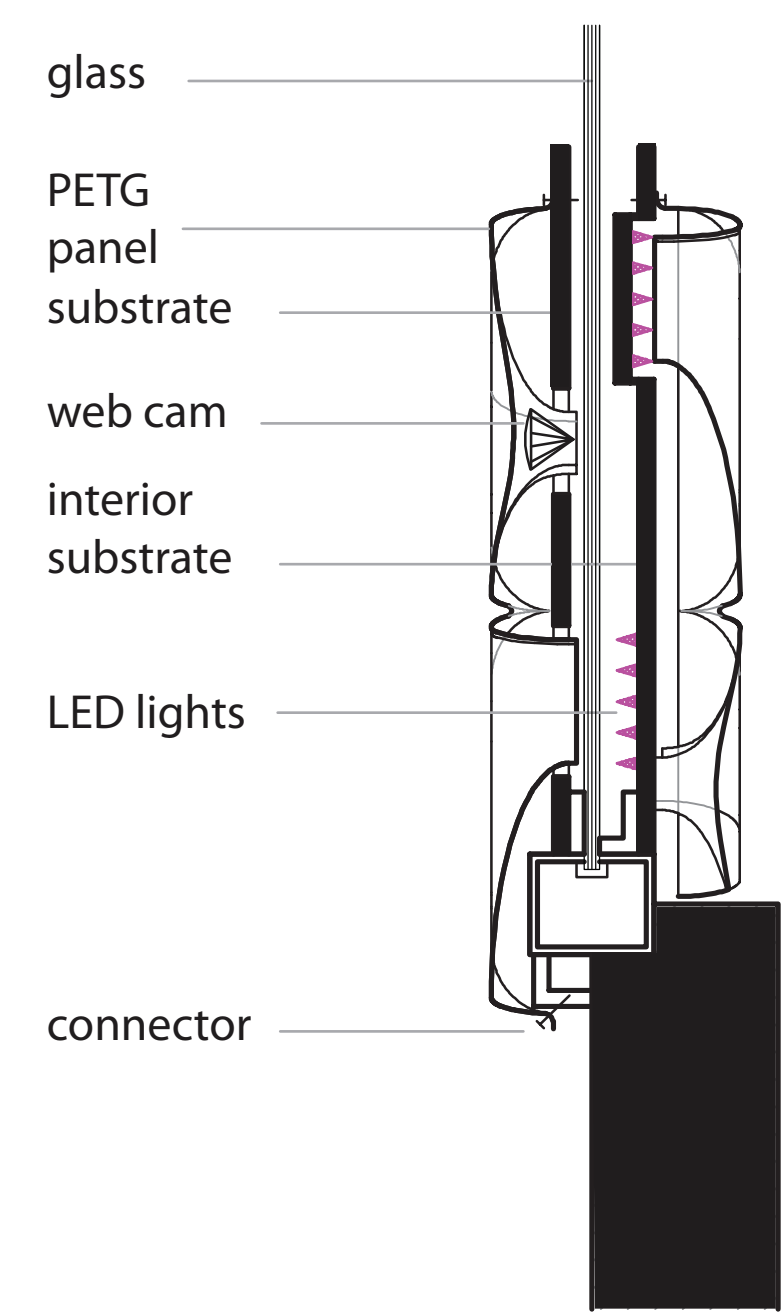

PANEL SECTION

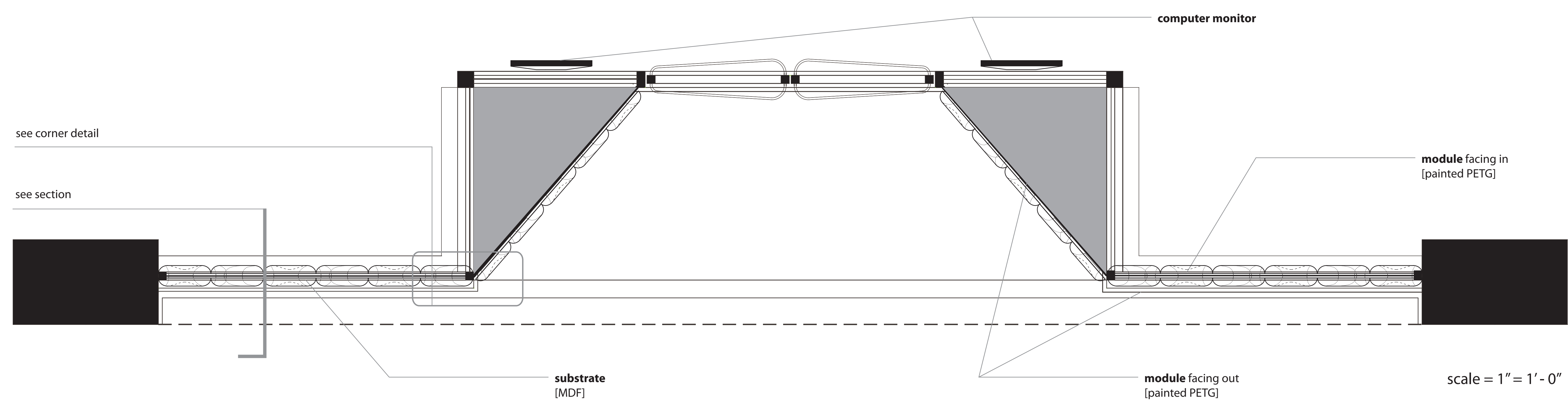

PLAN VIEW

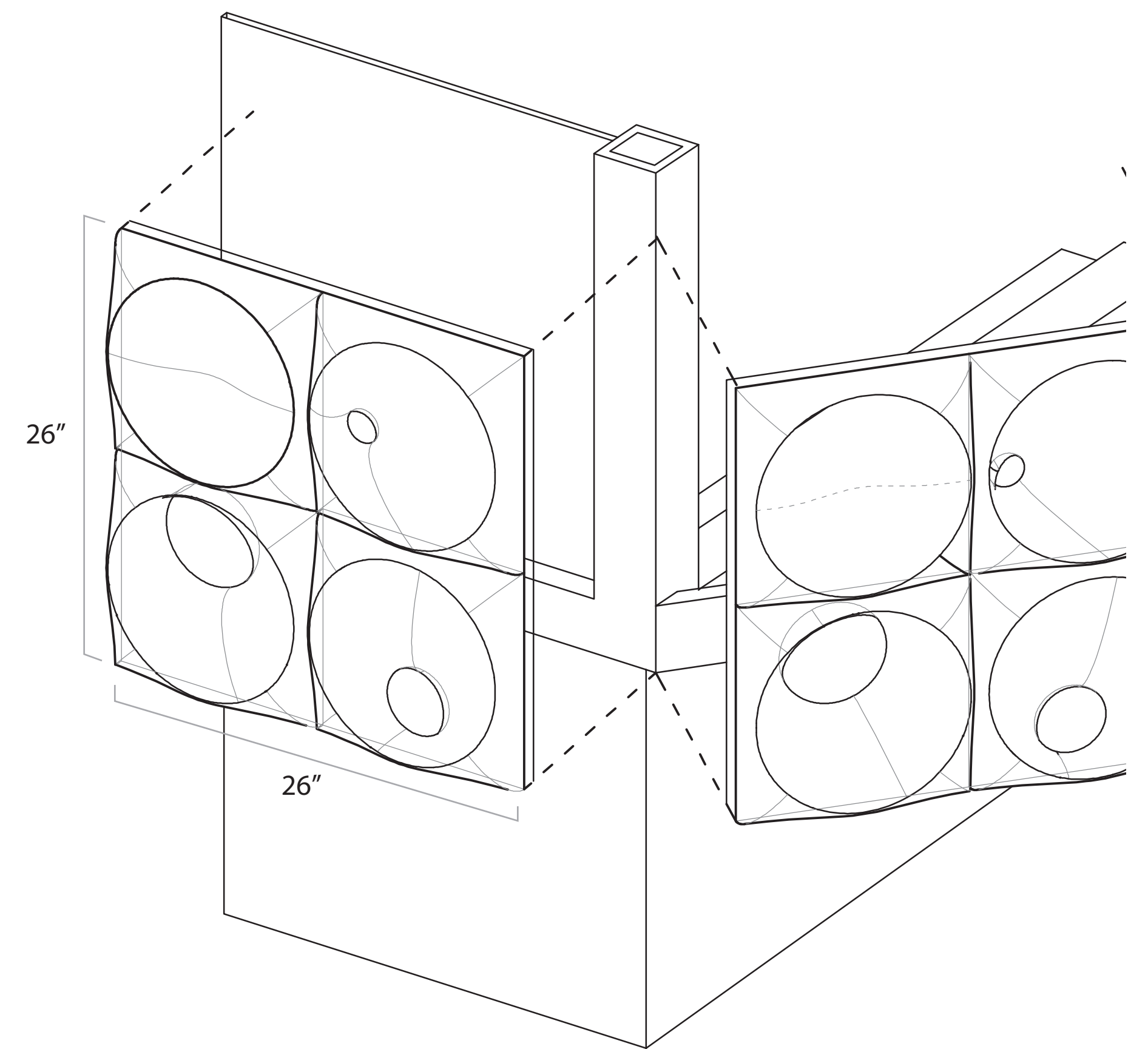

CORNER DETAIL

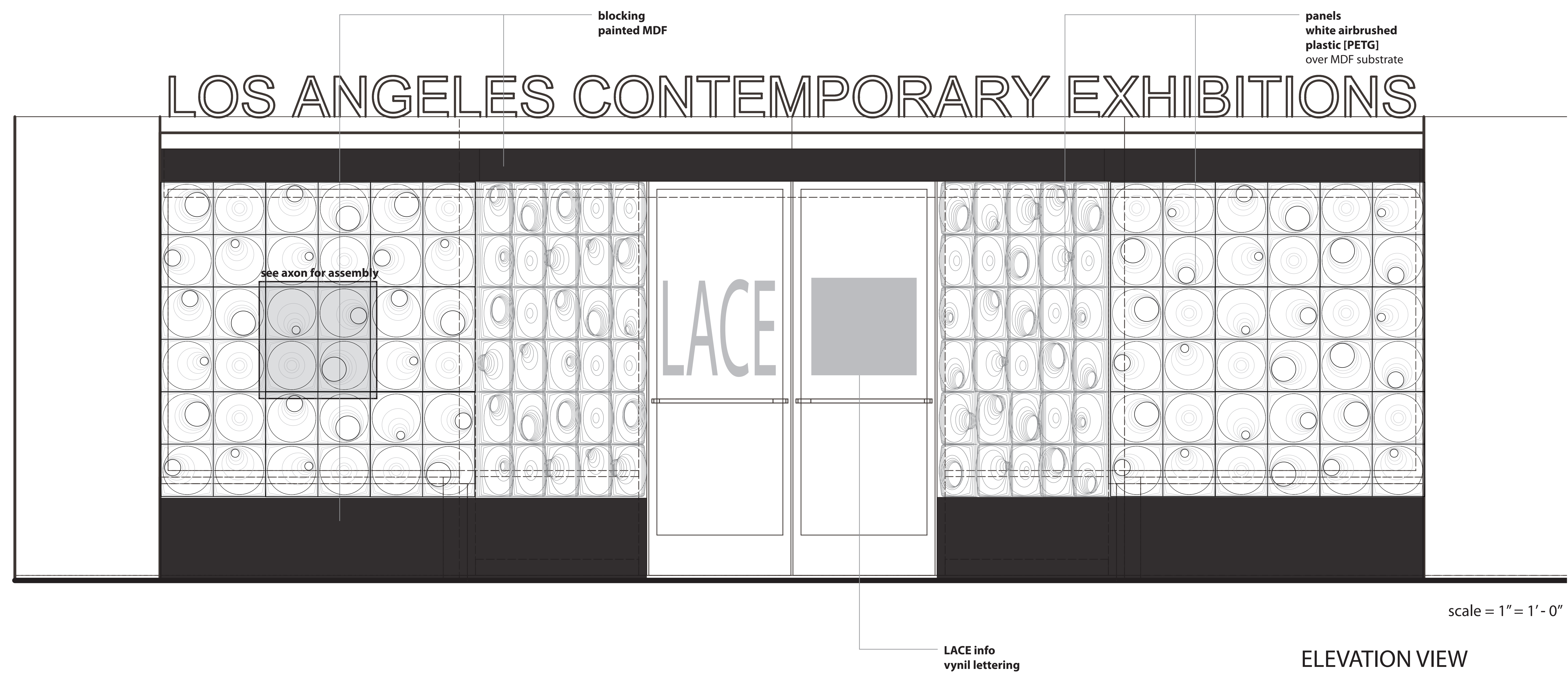

ELEVATION VIEW

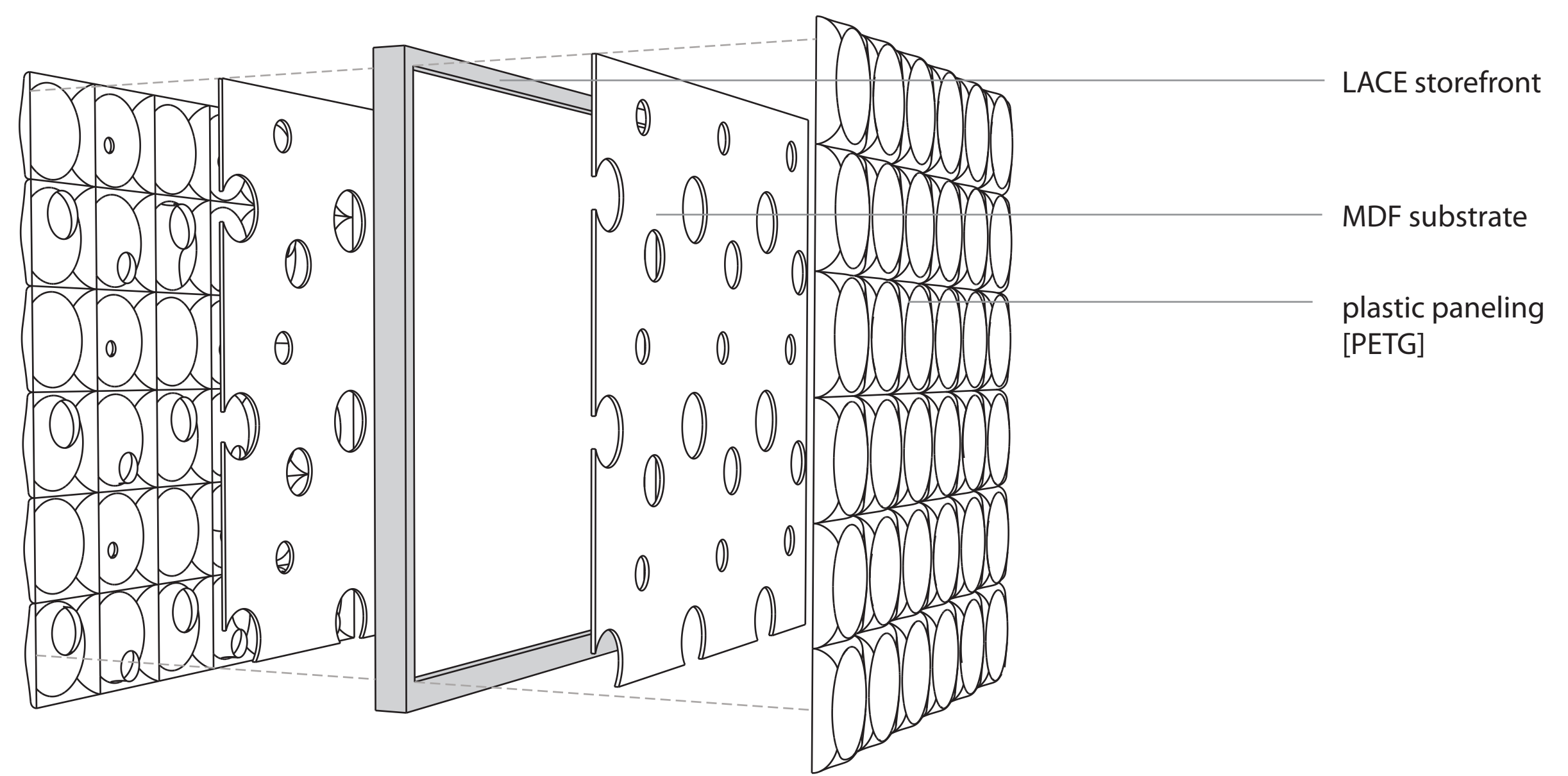

ASSEMBLY AXONOMETRIC

**SUPERFICIAL
SUPERGLOW**

ASSEMBLY STRATEGY

popMotion

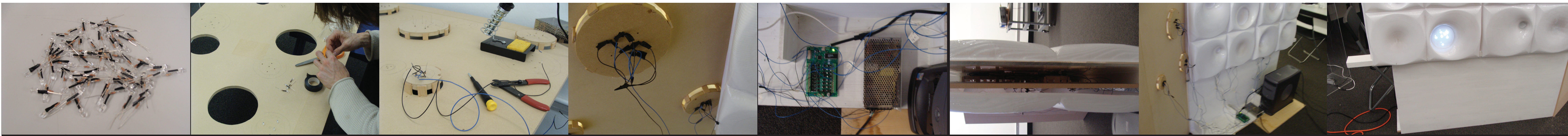

electronic components

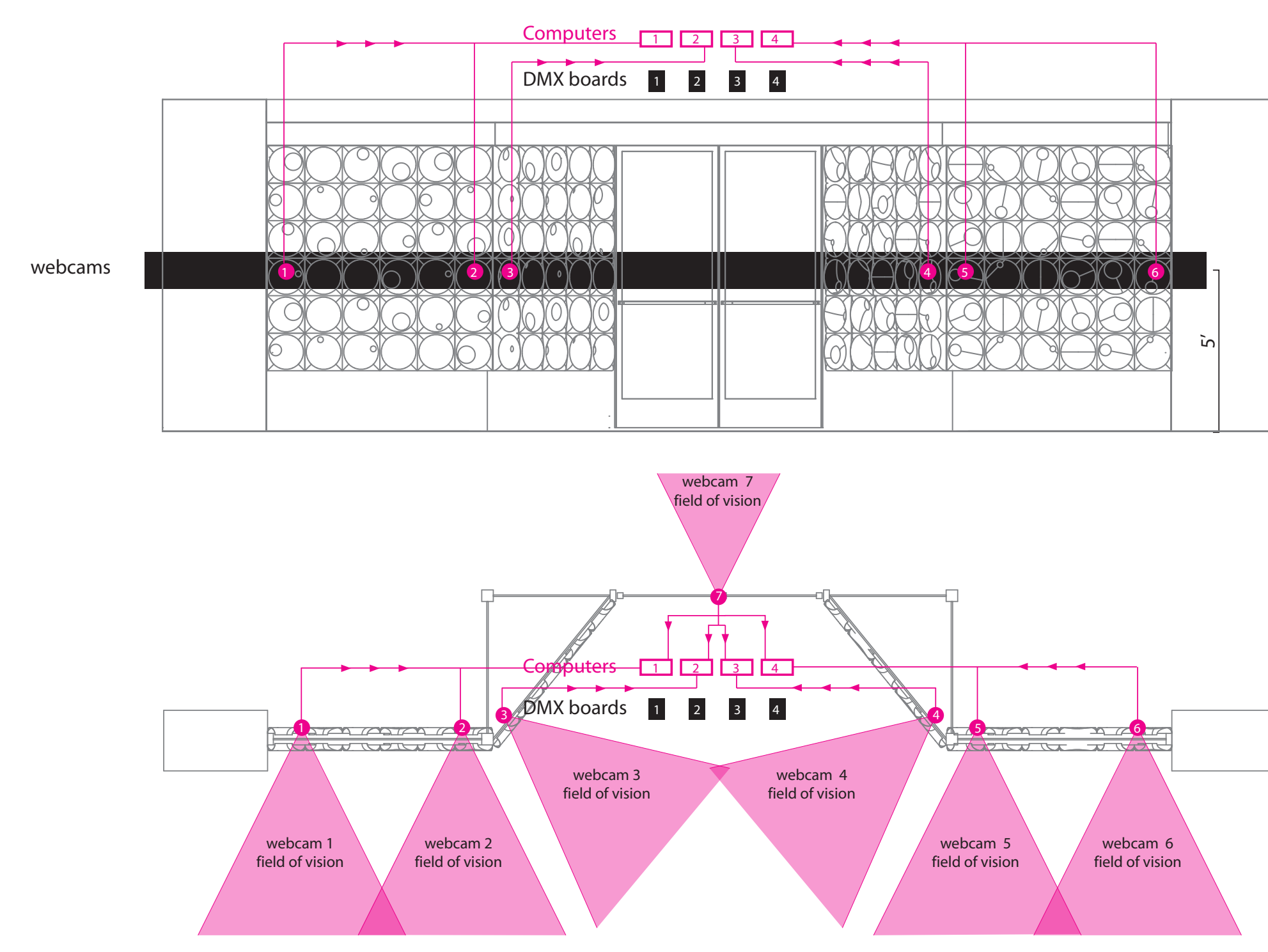

INPUT DIAGRAM

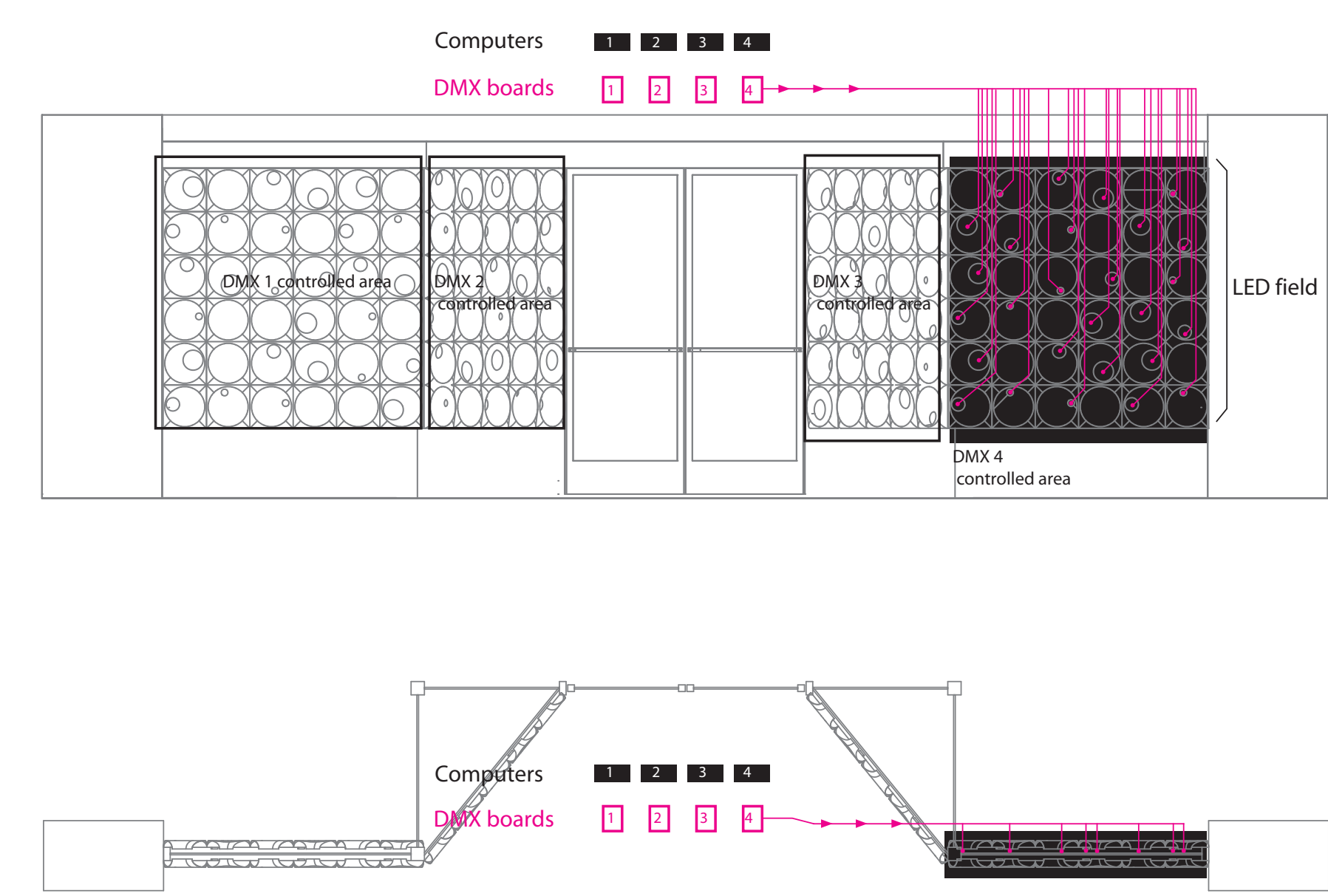

OUTPUT DIAGRAM

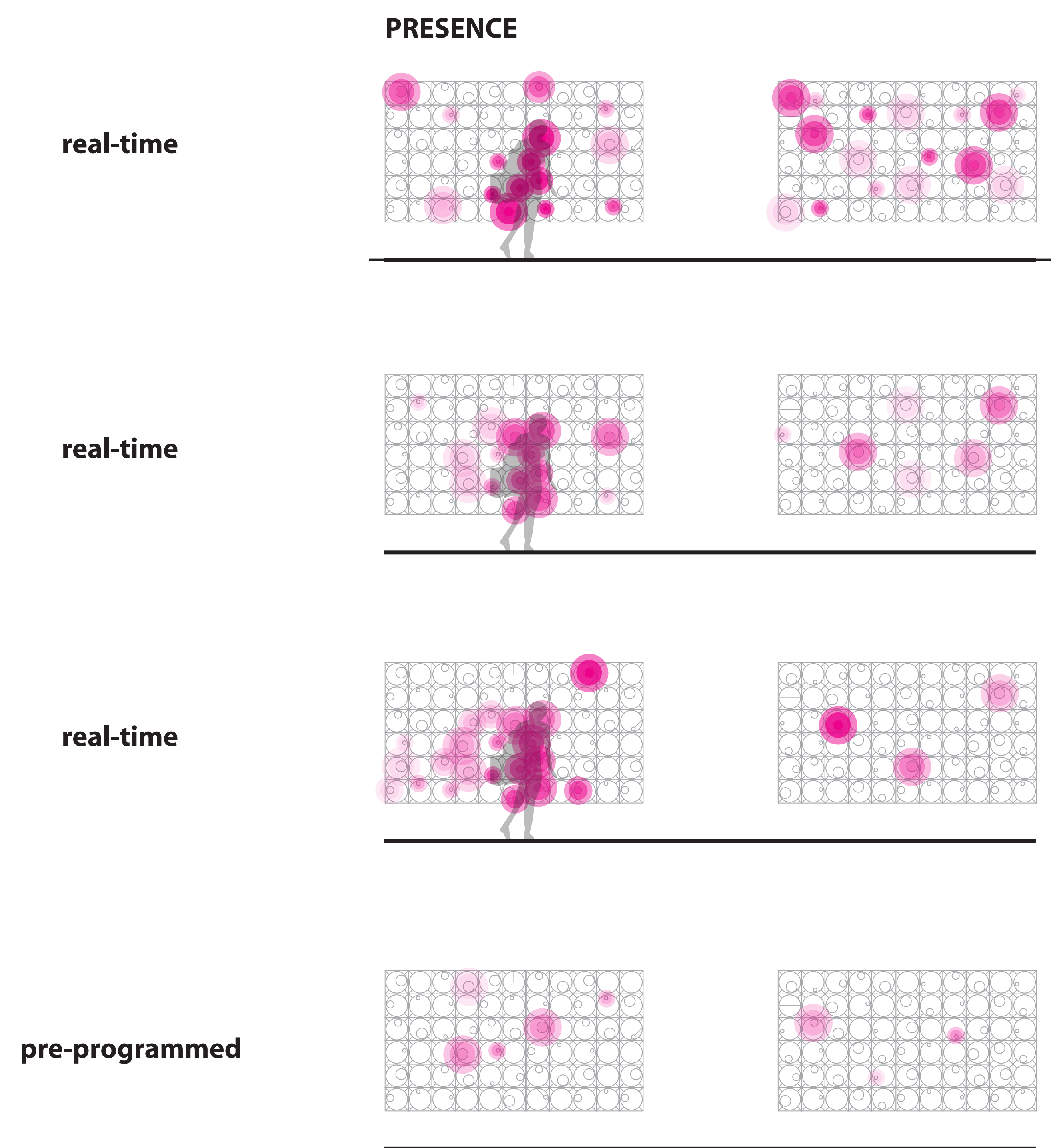
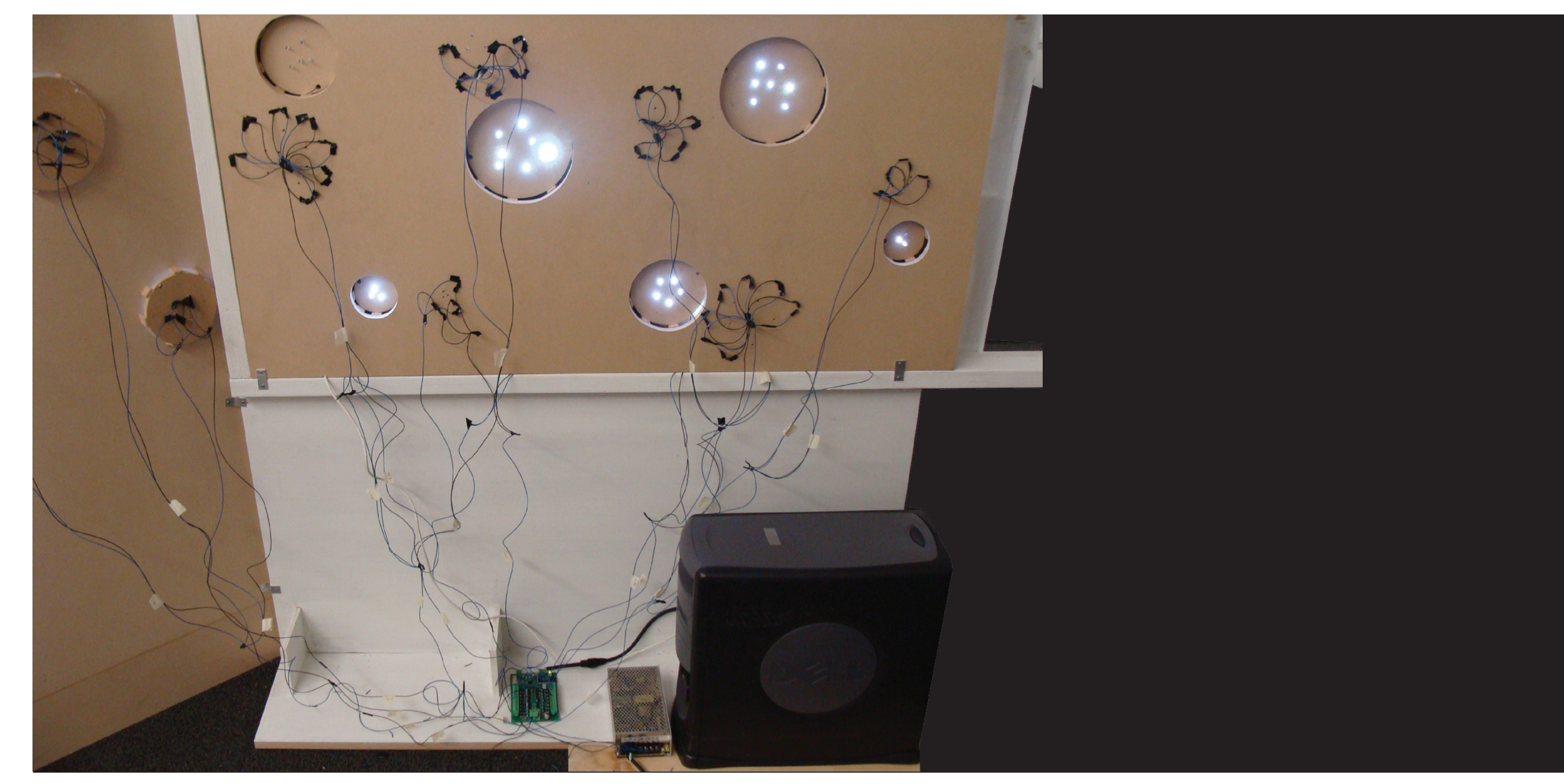

DIURNAL BEHAVIOR SCENARIO

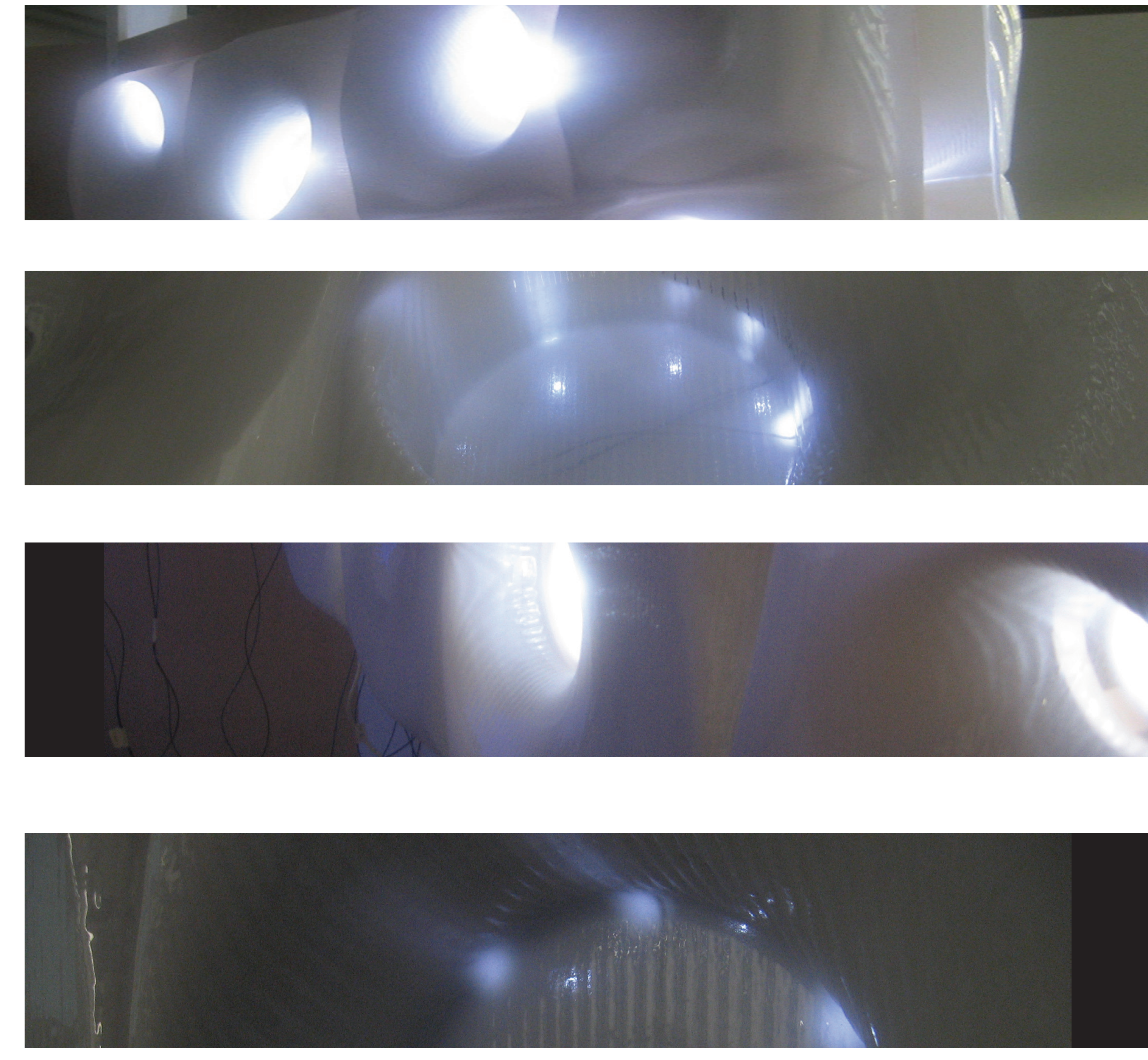
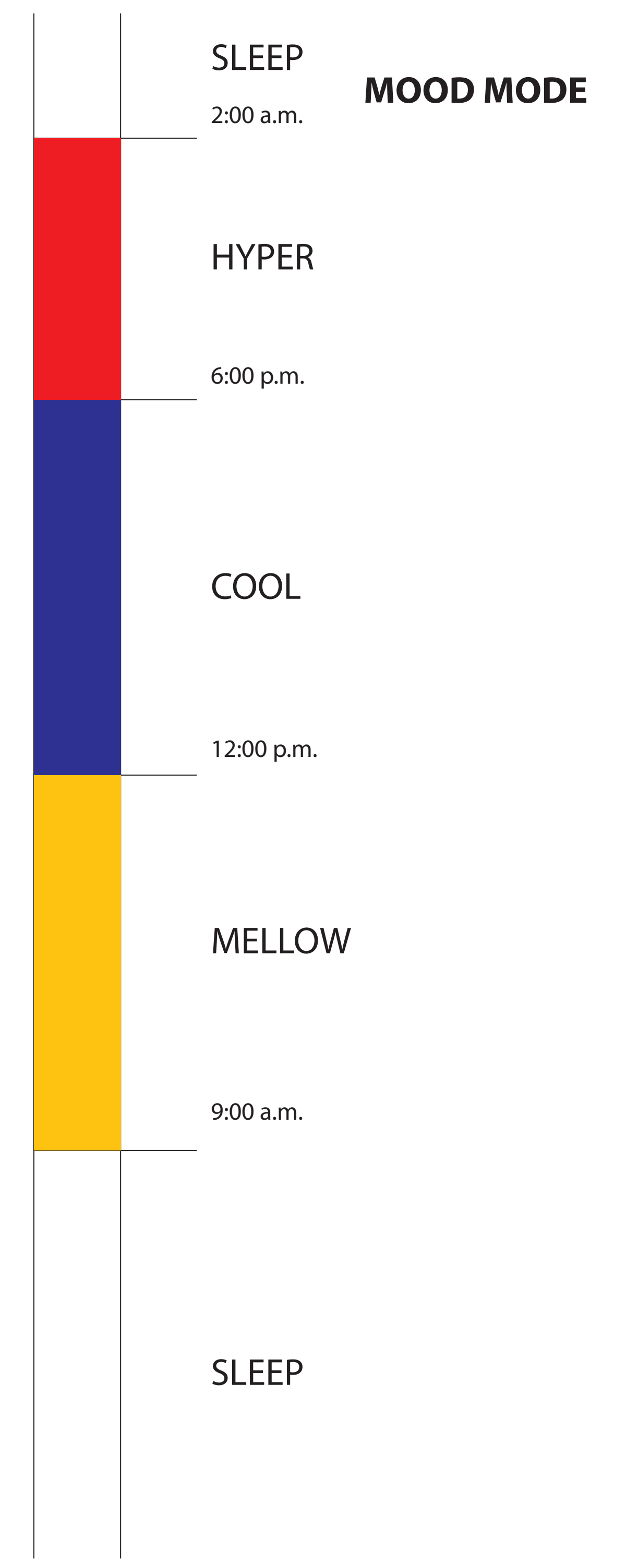
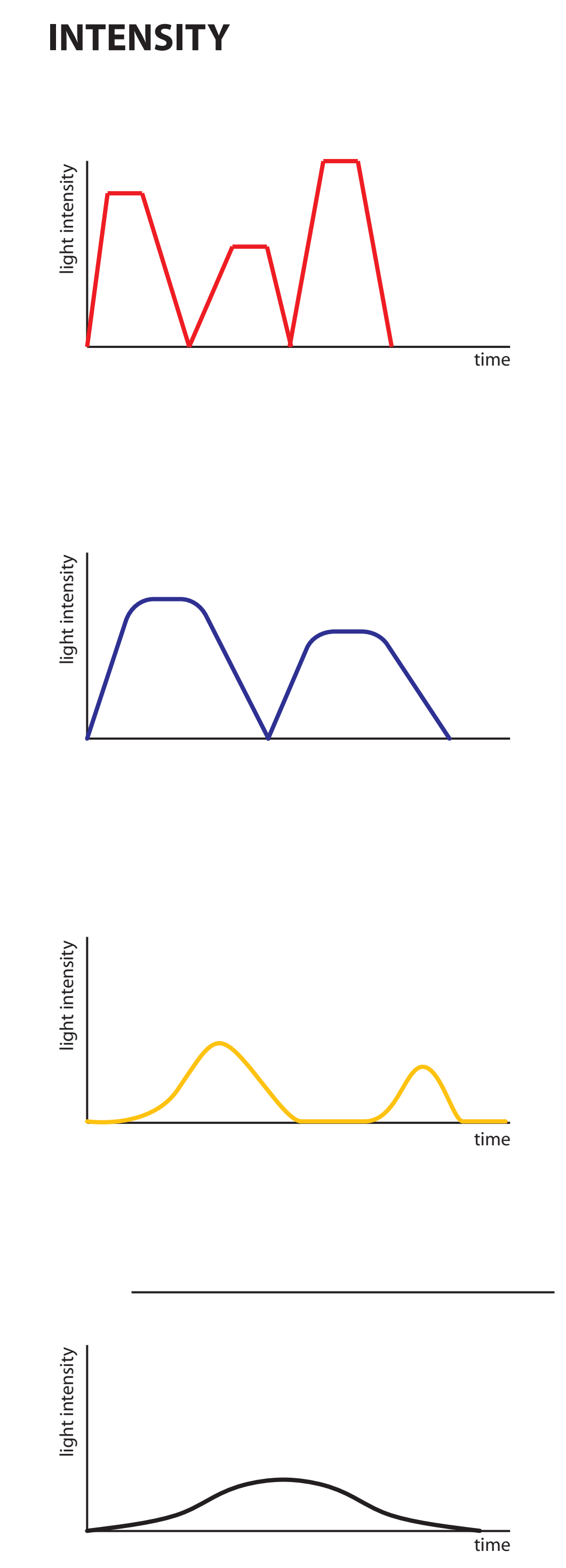

SUPERFICIAL
SUPERGLOW

LIGHT BEHAVIOR AND WIRING

popMotion